

# INSTRUCTION MANUAL



**THIN DECODER**

**MX600, MX600R, MX600P12**

**SUBMINIATURE – and MINIATURE DECODER**

**MX616, MX616N, MX616R**  
**MX617, MX617N, MX617R, MX617F**  
**MX621, MX621N, MX621R, MX621F**

MX620, MX620N, MX620R, MX620F, **MX622, MX622R, MX622F, MX622N**

**HO – and TT DECODER**

**MX623, MX623R, MX623F, MX623P12**  
**MX630, MX630R, MX630F, MX630P16**

**HO, (O) - DECODER for MORE POWER or LOW VOLTAGE output or MORE FUNCTIONS**

MX631, MX631R, MX631F, MX631D, MX631C

MX632, MX632R, MX632D, MX632C, MX632V, MX632W, MX632VD, MX632WD

**MX633, MX633R, MX633F, MX633P22, MX637P22**  
**MX634, MX634R, MX634F, MX634D, MX634C, MX638D, MX638C**

**MINIATURE - SOUND - DECODER**

**MX648, MX648R, MX648F, MX648P16**

MX647, MX647N, MX647L, MX646, MX646R, MX646F, MX646N, MX646L

**MX649, MX649R, MX649F, MX649N, MX649L**

**HO, (O) - SOUND - DECODER**

MX640, MX640R, MX640F, MX640D, MX640C,  
 MX642, MX642R, MX642F, MX642D, MX642C, MX643P16, MX643P22,

**MX645, MX645R, MX645F, MX645P16, MX645P22, MX644D, MX644C**

**NEXT 18 - DECODER**

**MX618N18**

**NEXT 18 – Sound - Decoder**

**MX658N18, MX659N18**

**and: ADAPTER BOARDS ADAPLU (15, 50), ADAMTC/MKL (15, 50), ADAPUS (15, 50)**

Decoder versions listed in gray are no longer in production

**EDITION:**

First edition. SW version 25.0 for MX620, MX630, MX64D and MX640 – 2009 07 15  
 SW version 26.0 – 2009 09 26  
 New MX631 decoder family included and CV amendments -- 2010 03 01  
 New MX643 decoders (PluX versions of the MX642) -- 2010 05 01  
 SW version 27.0 – 2010 07 25  
 SW version 28.3 – 2010 10 15  
 New decoder families MX646 and MX645 included, SW version 28.5 – 2010 12 01  
 SW version 28.13 – 2011 01 12  
 SW version 28.25 – 2011 03 10  
 SW-Version 30.7 --- 2011 07 05

SW-Version 31 --- 2012 08 11  
 Loco boards chapter --- 2012 11 28  
 New Family MX634 --- 2013 04 04  
 SW-Version 33.0 --- 2013 04 20  
 2013 06 01  
 SW-Version 34.0 – 2014 01 01  
 2014 10 12  
 2015 02 18  
 2015 07 14  
 MX649 added --- 2015 10 12  
 SW-Version 35.0 --- 2015 12 15  
 MX600 included --- 2016 02 02  
 2016 12 15  
 2018 04 13

1	Overview.....	2
2	Technical Information.....	5
3	Address and CV Programming.....	13
3.1	Programming in "Service mode" (on programming track).....	14
3.2	Programming in "Operations Mode" (on-the-main "PoM").....	15
3.3	Decoder-ID, Load-Code, Decoder-Type and SW-Version.....	15
3.4	The vehicle address(es) in DCC mode.....	15
3.5	Analog operation.....	16
3.6	Motor Regulation.....	17
3.7	Acceleration and Deceleration:.....	20
3.8	Special Operating Mode "km/h – speed regulation".....	21
3.9	The ZIMO "signal controlled speed influence" (HLU).....	22
3.10	"Asymmetrical DCC-Signal" stops (Lenz ABC).....	23
3.11	DC Brake Sections, "Märklin brake mode".....	24
3.12	Distance controlled stopping – Constant stopping distance.....	24
3.13	Shunting, Half-Speed and MAN Functions:.....	25
3.14	The NMRA-DCC function mapping.....	26
3.15	The extended ZIMO function mapping (not for MX621).....	26
3.16	"Unilateral Light Suppression".....	27
3.17	The "Swiss Mapping".....	27
3.18	The ZIMO "Input Mapping".....	30
3.19	Dimming, Low beam and Direction Bits.....	30
3.20	Flasher Effect.....	32
3.21	F1-Pulse Chains (Only for old LGB products).....	32
3.22	Special Effects for Function Outputs.....	32
3.23	Configuration of Smoke Generators (for sound decoders).....	33
3.24	Configuration of Electric Uncouplers.....	34
3.25	SUSI-Interface and Logic-Level Outputs (NOT for MX621).....	35
3.26	Servo Configuration (NOT for MX621).....	35
4	Feedback - "Bidirectional communication".....	36
5	ZIMO SOUND – Selection and Programming.....	37
5.1	The "CV #300 procedures".....	39
5.2	"Incremental Programming" of sound CV's, an alternative to "normal" programming.....	42
5.3	The test run for determining the motor's basic load.....	42
5.4	Basic settings independent of powertrain.....	42
5.5	Steam engine → Basic sound settings.....	44
5.6	Steam engine → Load and acceleration dependency.....	46
5.7	Diesel and Electric engines →.....	48
5.8	Random and Switch Input sounds.....	52
6	Installation and Wiring.....	52
7	ADAPTER boards, Energy storage.....	63
8	Predefined CV sets.....	67
9	ZIMO decoders and competitor systems.....	69
10	DC and AC Analog Operation.....	70
11	CV – Summary List.....	71
12	Service Notes.....	78
13	INDEX.....	79

ZIMO decoders contain an EPROM which stores software that determines its characteristics and functions. The software version can be read out from CV #7 and #65. The current version may not yet be capable of all the functions mentioned in this manual. As with other computer programs, it is also not possible for the manufacturer to thoroughly test this software with all the numerous possible applications. Installing new software versions later can add new functions or correct recognized errors. SW updates can be done by the end user for all ZIMO decoders since production date October 2004, see chapter "Software Update"! Software updates are available at no charge if performed by the end user (except for the purchase of a programming module); Updates and/or upgrades performed by ZIMO are not considered a warranty repair and are at the expense of the customer. The warranty covers hardware damage exclusively, provided such damage is not caused by the user or other equipment connected to the decoder. For update versions, see [www.zimo.at](http://www.zimo.at).

## 1 Overview

These decoders are suitable for N, HOe, HOm, TT, HO, OO, Om and O gauge engines. They operate in the **NMRA-DCC data format** as well as the **MOTOROLA protocol**, in **DC analog mode** with DC power packs (including PWM) and with **AC analog** (Märklin Transformers with over-voltage pulses for direction change. Exception: MX621 and MX640)).

25 x 11 x 2 mm Non-Sound - 0.8 A - 4 Fu-Outputs – **DCC and DC**

<b>MX600 Family</b>	<b>“Thin decoder“</b> , single layer board, especially low priced NOTE to Typ <i>MX600P12</i> (with PluX-12 interface): the dimensions of this design do NOT correspond to the PluX standard.
---------------------	---

MX600 plug configurations:

<b>MX600</b>	9 wires (120mm long) for power pick-up, motor and 4 function outputs.
<b>MX600R</b>	MX600, with 8-pin plug as per NEM652 on 70mm wires.
<b>MX600P12</b>	As MX600, with <b>12 pin PluX connector</b> mounted on circuit board.

8 x 8 x 2.4 mm Non-Sound - 0,7 A - 6 Fu-Outputs -- **DCC, MM and DC**

<b>MX616 Family</b>	<b>Subminiature-Decoders</b> , with reduced. Fu Mapping ZIMO characteristics; TYPICAL APPLICATION: vehicles in N, HOe, HOm.
---------------------	--

MX616 plug configurations:

<b>MX616</b>	7 wires for power pick-up, motor, 2 function outputs (120 mm). 4 more function outputs on solder pads.
<b>MX616N</b>	As MX616, with 6-pin plug as per NEM651, mounted on the circuit board.
<b>MX616R</b>	As MX616, with 8-pin plug as per NEM652 on 70mm wires.

13 x 9 x 2.6 mm Non-Sound - 0,7 A - 6 Fu-Outputs -- **DCC, MM and DC**

<b>MX617 Family</b>	<b>Subminiature-Decoder</b> , with reduced Fu Mapping ZIMO characteristics; TYPICAL APPLICATION: Vehicles in N, HOe, HOm.
---------------------	--

MX617 plug configurations:

<b>MX617</b>	7 wires for power pick-up, motor, 2 function outputs (120 mm). 4 more function outputs on solder pads.
<b>MX617N</b>	As MX617, with 6-pin plug as per NEM651, mounted on the circuit board..
<b>MX617R</b>	As MX617, with 8-pin plug as per NEM652 on 70mm wires
<b>MX617F</b>	As MX617, with 6-pin plug as per NEM651 on 70mm wires.

15 x 9.5 x 2.8 mm Non-Sound - 0.7 A - 4 Fu-Outputs + 2 logic level – **SUSI - DCC, MM, DC, AC**

<b>MX618N18</b>	<b>Next 18 – Decoder</b> (“Railcommunity” Interface-Standard RCN-118)
-----------------	---

**MX620** *Out of production since June of 2010; replaced by MX621 and MX622.*

12 x 8.5 x 2.2 mm Non-Sound - 0.7 A DCC and DC-Analog (**not for MOTOROLA**)

<b>MX621 Family</b>	<b>Sub-miniature Decoder</b> , with reduced ZIMO features. TYPICAL APPLICATION: Vehicles in N, HOe and HOm.
---------------------	--

MX621 plug configurations:

<b>MX621</b>	7 wires (120mm long) for power pick-up, motor and 2 function outputs. Two more function outputs on solder pads.
<b>MX621N</b>	MX621 with 6-pin plug as per NEM651, mounted on the circuit board.
<b>MX621R</b>	MX621 with 8-pin plug as per NEM652 on 70mm wires.
<b>MX621F</b>	MX621 with 6-pin plug as per NEM651 on 70mm wires.

14 x 9 x 2.5 mm Non-Sound - 0.8A - 6 Fu-Outputs - 2 Servos - **SUSI DCC, MM, DC, AC**

<b>MX622 Family</b>	<b>Miniature-Decoder</b> , with all ZIMO features. TYPICAL APPLICATION: N, HOe, HOm; and HO vehicles with limited space.
---------------------	---

MX622 plug configurations:

<b>MX622</b>	7 wires (120mm long) for power pick-up, motor and 2 function outputs. Two more function outputs on solder pads.
<b>MX622R</b>	MX622 with 8-pin plug as per NEM652 on 70mm wires.
<b>MX622F</b>	MX622 with 6-pin plug as per NEM651 on 70mm wires.
<b>MX622N</b>	MX622 with 6-pin plug as per NEM651, mounted on circuit board.

20 x 8.5 x 3.5 mm Non-Sound - 0.8 A - 4 Fu-Outputs - 2 Servos - **SUSI DCC, MM, DC, AC**

<b>MX623 Family</b>	<b>Small Decoder</b> ; built especially narrow for universal applications in tight spaces. TYPICAL APPLICATION: HO and TT... Due to excellent dielectric strength (50V), it is also suitable for AC analog with the old Märklin transformer.
---------------------	---

MX623 plug configurations:

<b>MX623</b>	9 highly flexible wires (120mm) for pick-up, motor and 2 function outputs. Solder pads for 4 additional logic level outputs, two of them as servo outputs or SUSI.
<b>MX623R</b>	MX623 with 8-pin plug as per NEM652 on 70mm wires.
<b>MX623F</b>	MX623 with 6-pin plug as per NEM651 on 70mm wires.
<b>MX623P12</b>	MX623 with <b>12 pin PluX connector</b> , mounted on circuit board.

20 x 11 x 3.5mm Non-Sound - 1.0A - 6 Fu-Outputs - 2 Servos - SUSI **DCC, MM, DC, AC**

<b>MX630</b> Family	<b>Compact HO loco decoder</b> , for universal applications. TYPICAL APPLICATION: HO. Due to excellent dielectric strength (50V), the decoder is also suitable for AC analog operation with the old Märklin transformers.
------------------------	--

MX630 plug configurations:

<b>MX630</b> <b>MX630R</b> <b>MX630F</b> <b>MX630P16</b>	9 highly flexible wires (120mm) for pick-up, motor and 4 function outputs. Solder pads for 2 additional logic level outputs, servo outputs or SUSI. MX630 with 8-pin plug as per NEM652 on 70mm wires. MX630 with 6-pin plug as per NEM651 on 70mm wires. MX630 with <b>16-pin PluX connector</b> , mounted on circuit board.
---	--

<b>MX631</b>	<i>Out of production since December of 2012; replaced by MX634.</i>
--------------	---

28 x 15.5 x 4mm Non-Sound - 1.6A - 8 Fu-Outputs - 2 Servos - SUSI **DCC, MM, DC, AC**

<b>MX632</b> Family	<b>High output decoder, with built-in energy storage circuitry.</b> TYPICAL APPLICATION: HO, O and similar gauge, especially for vehicles with low-voltage bulbs (1.5 or 5V).
------------------------	--

MX632 plug configurations:

<b>MX632</b>	11 highly flexible wires (120mm) for pick-up, motor and 4 function outputs. Solder pads for 4 additional logic level outputs, servo outputs or SUSI.
<b>MX632R</b>	MX632 with 8-pin plug as per NEM652 on 70mm wires.
<b>MX632D</b>	MX632 with <b>21-pin "MTC" plug</b> mounted on decoder board.
<b>MX632C</b>	As MX631D but for <b>Märklin, Trix or similar</b> ; FO3, FO4 as logic level outputs.
<b>MX632V, VD</b> <b>MX632W, WD</b>	Decoders with <b>low voltage supply for function outputs</b> : ...V = 1.5V, ...W = 5V, ...VD or ...WD = with 21-pin plug.

22 x 15 x 3.5 mm Non-Sound - 1.2 A - 10 Fu-Outputs - 2 Servos - SUSI **DCC, MM, DC, AC**

<b>MX633</b> Family	<b>Decoder with 10 functions, large processor and energy storage circuitry</b> TYPICAL APPLICATION: HO and O gauge, if lots of functions are required, also: this is the only (first) HO decoder usable with gold caps!
------------------------	--

MX633 plug configurations:

<b>MX633</b> <b>MX633R</b> <b>MX633P22</b>	11 highly flexible wires (120mm) for pick-up, motor and 4 function outputs. Solder pads for 6 additional outputs, logic level, servo outputs as well as SUSI. MX633 with 8-pin plug as per NEM652 on 70 mm wires. MX633 with <b>22-pin PluX connector</b> mounted on decoder board.
--	---

20.5 x 15.5 x 3.5 mm Non-Sound - 1.2 A - 6 Fu-Outputs - 2 Servos - SUSI

<b>MX634</b> Family	<b>HO-Decoder, with large processor (as MX63) and energy storage circuitry</b> TYPICAL APPLICATION: HO and (smaller) O gauge.
------------------------	--

MX634 plug configurations:

<b>MX634D</b> <b>MX634C</b>	MX634 with <b>21-pin "MTC" plug</b> mounted on decoder board. MX634D but for <b>Märklin, Trix or similar</b> ; FO3, FO4 as logic level outputs.
--------------------------------	--

26 x 15 x 3,5 mm Non-Sound - 1,8 A - 10 Fu-Outputs - 2 Servos - SUSI - **DCC, MM, DC, AC**

<b>MX635</b> Family	<b>High performance-decoder, with energy storage circuitry, Low heat production because of synchronous rectifier, Types with low voltage supply for Fu-outputs.</b> TYPICAL APPLICATION: HO, gauge O.
------------------------	--

MX634 plug configurations:

<b>MX635</b> <b>MX635R</b> <b>MX635P22</b> <b>MX635V</b> <b>MX635W</b>	11 Anschlussleitungen (120 mm) für Schiene, Motor, 4 Fu-Ausgänge, Löt-Pads für 6 weitere Fu-Ausg., Logikpegel-Ausgänge, Servo-Steuerleitungen, SUSI. Wie MX635, with 8-pin plug as per NEM652 on 70mm wires. Wie MX635, with 6-pin plug as per NEM651 on 70mm wires Ausführungen mit <b>Niederspannungsversorgung</b> für die <b>Fu-Ausgänge</b> : ... V - 1,5 V ... W - 5 V
--	--

26 x 15 x 3.5 mm Non-Sound - 1,8 A - 6 Fu-Outputs - 2 Servos - SUSI - **DCC, MM, DC, AC**

<b>MX636</b> Family	<b>High performance-decoder, with energy storage circuitry, Low heat production because of synchronous rectifier, Types with low voltage supply for Fu-outputs.</b> TYPICAL APPLICATION: HO, gauge O.
------------------------	--

MX636 plug configurations:

<b>MX636D</b> <b>MX636C</b> <b>MX636VD</b> <b>MX636VW</b>	.With <b>21-pole "MTC" - interface</b> mounted on decoder board. As MX636D, about FA3, FA4 as logic level outputs Version with <b>low voltage supply for Fu-outputs</b> : ... V - 1,5 V ... W - 5 V
--	--

22 x 15 x 3.5 mm Non-Sound - 1,0 A - 9 Fu-Outputs - 2 Servos - SUSI - **DCC, MM, DC, AC**

<b>MX637P22</b>	<b>HO decoder only with PluX-22 interface</b>
-----------------	---

20.5 x 15.5 x 3.5 mm Non-Sound - 1,0 A - 6 Fu-Outputs - 2 Servos - SUSI - **DCC, MM, DC, AC**

<b>MX638D,C</b>	<b>HO decoder only with PluX-22 interface MTC-21 (21MTC)</b>
-----------------	--

**SOUND DECODERS:****MX647, MX646**

Production ended in 2012 and 2015 respectively;  
replaced by MX649.

20 x 11 x 4mm **SOUND** - 0.8A - 6 Fu-Outputs - 2 Servos - SUSI

**MX648**  
Family

**Subminiature-Sound-Decoder, 1 Watt Audio on 8 Ohm speaker**

TYPICAL APPLICATION: Vehicles in N, TT, HOe, HOm and in HO vehicles with limited space.

MX648 plug configurations:

<b>MX648</b>	11 highly flexible wires for pick-up, motor, 4 Fu-Outputs, speaker, solder pads for 2 more Fu-Outputs as logic level outputs, servos and SUSI.
<b>MX648R</b>	MX648 with 8-pin plug as per NEM652 on 70mm wires.
<b>MX648F</b>	MX648 with 6-pin plug as per NEM651 on 70mm wires.
<b>MX648P16</b>	MX648 with <b>16-pin PluX connector</b> (male), 4 function outputs through plug.

23 x 9 x 4mm **SOUND** - 1.0A - 4 Fu-Outputs - 2 Servos - SUSI

**MX649**  
Family

**Miniature-Sound-Decoder, 1 Watt Audio on 8 Ohm speaker**

TYPICAL APPLICATION: Vehicles in N, TT, HOe, HOm and in HO vehicles with limited space.

MX649 plug configurations:

<b>MX649</b>	11 highly flexible wires for pick-up, motor, 4 Fu-Outputs, speaker, 2 solder pads for logic level outputs, servos and SUSI.
<b>MX649N</b>	MX649 with 6-pin plug as per NEM651 mounted on circuit board and two additional speaker wires.
<b>MX649L</b>	MX649 with <b>90°</b> 6-pin plug as per NEM651 mounted on circuit board and two additional speaker wires.
<b>MX649R</b>	MX649 with 8-pin plug as per NEM652 on 70mm wires.
<b>MX649F</b>	MX649 with 6-pin plug as per NEM651 on 70mm wires.
<b>MX647L</b>	Produced only during Oct. 2010, before the MX646 became available.

**MX640, MX642, MX643**

Production ended in 2011;  
replaced by MX645 and MX644.

30 x 15 x 4mm **SOUND** - 1.2A - 8 - 10 Fu-Outputs - 2 Servos - SUSI

**MX645**  
and  
**MX644**  
Family

**MX645 and MX644 replace MX640, MX642 MX643...**

**H0-Sound-Decoder with 10 (MX645) or 6 (MX644) function outputs, 3 Watt audio on 4 Ohm speaker (or 2 x 8 Ohm), with energy storage circuitry.**

TYPICAL APPLICATION: HO, O and similar gauges.

MX645/MX644 plug configurations: **ATTENTION: OEM installed decoder sometimes have less function outputs.**

<b>MX645</b>	13 highly flexible wires (120mm) for pick-up, motor, 4 Fu-Outputs, speaker, energy storage circuitry, solder pads for additional 6 Fu-Outputs, servos and SUSI.
<b>MX645R</b>	MX645 with 8-pin plug as per NEM652 on 70mm wires.
<b>MX645F</b>	MX645 with 6-pin plug as per NEM651 on 70mm wires.
<b>MX645P16</b>	MX645 with <b>16-pin PluX connector</b> , 4 Fu-Outputs through plug.
<b>MX645P22</b>	MX645 with <b>22-pin PluX connector</b> , 9 Fu-Outputs (+ extra output outside plug).
<b>MX644D</b>	Similar to MX645 but with <b>21-pin "MTC" plug</b> mounted on circuit board.
<b>MX644C</b>	Similar to MX645 but for <b>Märklin-, Trix etc.</b> ; with FO3, FO4 logic level only.

25 x 10.5 x 4mm **SOUND** - 0.8A - 4 Fu-Outputs + 2 Logic level - SUSI

**MX658N18**

**Next18 Sound-Decoder**, ("Rail community" standard RCN-118)

20 x 9,5 x 4 mm **SOUND** - 0,8 A - 4 Fu-Ausgänge + 2 Logikpegel - SUSI - **DCC, MM, DC, AC**

**MX659N18**

**Next18 - Sound-Decoder** („Railcommunity" Norm RCN-118)

## 2 Technical Information

Allowable track voltage .....	min. 10 V
MX620, MX640 (discontinued), MX616 .....	max. 24 V
MX600 .....	max. 30 V
MX617, MX618, MX621, MX622, MX623, MX634 .....	max. 35 V
MX646, MX647, MX648, MX649, MX658 .....	max. 35 V
MX630, MX631, MX632, MX633, MX644, MX645 ... digital or DC-analog .....	max. 35 V
MX630, MX631, MX632, MX633, MX634, MX644, MX645 with AC analog, ...	max. pulse... 50 V
max. continuous motor current: MX616, MX617, MX618, MX620, MX621, MX649 .....	0,7 A
MX600, MX622, MX623, MX648, MX658 .....	0,8 A
MX630, MX631, MX646 .....	1,0 A
MX633, MX634, MX640, MX642, MX643, MX644, MX645 .....	1,2 A
MX632 .....	1,6 A
Adapter board ADAPLU or ADAMTC with decoder .....	1,8 A
Peak motor current: MX600, MX616, MX617, MX618, MX620, MX621, MX623, MX646 .....	1,5 A
MX648, MX649, MX658 .....	1,5 A
MX630 to MX634, MX640 to MX645 for about 20 sec .....	2,5 A
Maximum total function output, continuous *) MX616, MX617, MX618, MX620 .....	0,5 A
MX621, MX646 to MX658 .....	0,5 A
MX630 to MX634, MX640 to MX645 .....	0,8 A
Maximum continuous current for LED outputs .. MX640, MX642, MX644 .....	10 mA each
Maximum continuous total current (motor <b>and</b> functions) .....	= maximum continuous motor current
operating temperature .....	- 20 to 100 °C
MX640 to MX660: Sound sample memory .....	32 Mbit (= 180 sec at 22 kHz)
MX640 to MX660: Sample rate .....	depending on sound sample... 11 or 22 kHz
MX640 to MX660: Number of independent sound channels .....	6
MX640 to MX660: Sound amplifier output (Sinus) .....	(MX640, MX646, MX648) 1,1 W, (others) 3 W
Speaker impedance .....	(MX640, MX646 to MX660) 8 Ohm, (others) 4 Ohm
Dimensions (L x W x H) .....	
MX600, MX600P12 .....	25 x 11 x 2 mm
MX616 .....	8 x 8 x 2.4 mm
MX617 .....	13 x 9 x 2.6 mm
MX618 .....	15 x 9,5 x 2.8 mm
MX620, MX620N (excluding pins) .....	14 x 9 x 2.5 mm
MX621, MX621N (excluding pins) .....	12 x 8,5 x 2.2 mm
MX622, MX622P16 (height without pins) .....	16 x 9 x 2.5 mm
MX623, MX623P16 .....	20 x 8,5 x 3.5 mm
MX630, MX630P16 (height without pins) .....	20 x 11 x 3.5 mm
MX631, MX631D/C, MX634, MX634D/C .....	20.5 x 15.5 x 4 mm
MX632, MX632D .....	28 x 15.5 x 4 mm
MX633, MX633P22, MX637 .....	22 x 15 x 3.5 mm
MX635, MX636 .....	26 x 15 x 3.5 mm
MX634, MX638 .....	20.5 x 15.5 x 3.5 mm
MX646, MX646N .....	28 x 10.5 x 4 mm
MX648, MX648P16 (height without pins) .....	20 x 11 x 4 mm
MX648N, MX649N (without pins) .....	23 x 9 x 4 mm
MX640 .....	32 x 15.5 x 6 mm
MX642, MX643, MX644, MX645 .....	30 x 15 x 4 mm
MX658 .....	25 x 10.5 x 4 mm
MX659 .....	20 x 9.5 x 3 mm
MX660 .....	42 x 9 x 4.2 mm
Adapter boards ADAPLU -MTC with decoder .....	45 x 15 (26,5) x 4 (6) mm

\*) The short circuit protection is carried out for the total current of all outputs. Use the "soft start" option (i.e. CV #125 = 52) to prevent cold-start problems of light bulbs (in-rush current interpreted as a short circuit, which leads to the output being turned off)!

**The decoder type can be read out in CV #250:**

190=MX659	199=MX600	200=MX82	201=MX620
194=MX660	195=MX616	196=KISS Silberlinge	197 = MX617
199= MX600	200=MX82	201=MX620	202=MX62
204=MX64	205=MX64H	206=MX64D	207=MX680
209=MX69	210=MX640	211=MX630-P2520	212=MX632
214=MX642	215=MX643	216=MX647	217=MX646
219=MX631-P25K22	220=MX632-P25K22	221=MX645	222=MX644
224=MX695-RevB	225=MX648	226=MX685	227=MX695-RevC
229=MX695N	230=MX696	231=MX696N	232=MX686
234=MX623	235=MX687	236=MX621-FLM	237=MX633
240=MX634	241=MX686B	242=MX820RevB	243=MX618
245=MX697	246=MX658	247=MX688	248=MX821
250=MX699	251=Roco 2067	252=Roco ICE	253=MX649
			254=MX697-RevB
			198=FLM_E69
			203=MX63
			208=MX690
			213=MX631
			218=MX630-P25K22
			223=MX621
			228=MX681
			233=MX622
			238=MX820RevA
			244=Roco NextG
			249=MX648-RevC,D

### Software Update:

ZIMO DCC decoders can be updated by the user. An update device such as the ZIMO decoder update module **MXDECUP**, from 2011 **MXULF**, system-cab **MX31ZL** or **command station MX10** is required. The update process is carried out by a flash drive (MXULF, MX31ZL / MX10) or by a PC with Windows operating system and the program ZIMO Firmware Flasher (in the bundle with ZSP).

The same hardware, but ZSP (software) is also used for uploading sound projects into ZIMO sound decoders.

There is no need to remove the decoder or to open up the locomotive. Just set the locomotive on a section of track connected to the update module and start the update with the computer or other equipment mentioned above.

NOTE: Equipment inside the locomotive that is powered directly from the track (not through the decoder) can interfere with the update procedure. The same is valid for energy buffers that are installed without heeding the advice in the "Installation and wiring" chapter, section "Use of an external energy source" (regarding a choke coil).

See the **last chapter** in this manual for more information on updating decoders or [www.zimo.at](http://www.zimo.at)!

Of course, SW updates can be done by ZIMO or your ZIMO dealer for a small fee.

### Overload and Thermal Protection:

The motor and function outputs of ZIMO decoders are designed with lots of reserve capacities and are additionally protected against excessive current draw and short circuits. Cut-outs are encountered if the decoder is overloaded.

**Even though the decoder is well protected, it is not indestructible. Please pay attention to the following:**

**Wrong decoder contact**, if, for instance, the motor leads have contact to track power or an overlooked connection between the motor brushes and rail pick-ups is not always recognized by the overload protection circuit and could lead to damage of the motor power amplifier or even a total destruction of the decoder.

**Unfit or defective motors** (e.g. shorted windings or commutator) are not always recognized by their high current consumption, because these are often just short current spikes. So, they can lead to decoder damage including damage to power amplifiers due to long-term exposure.

The power amplifiers of loco decoders (motor as well as function outputs) are not only at risk of overcurrent but also **voltage spikes**, which are generated by motors and other **inductive consumers**. Depending on track voltage, such spikes can reach several hundred volts and are absorbed by special protection circuits inside the decoder. This is why the voltage shall not be too high, i.e. not higher than intended by the corresponding vehicle.

All ZIMO decoders are equipped with temperature sensors to measure their own operating temperature. Power to the motor will be turned off once that temperature exceeds 100°C. The headlights start flashing rapidly, at about 5 Hz, to make this state visible to the operator. Motor control will resume automatically after a drop in temperature of about 20°C, typically in about 30 seconds.

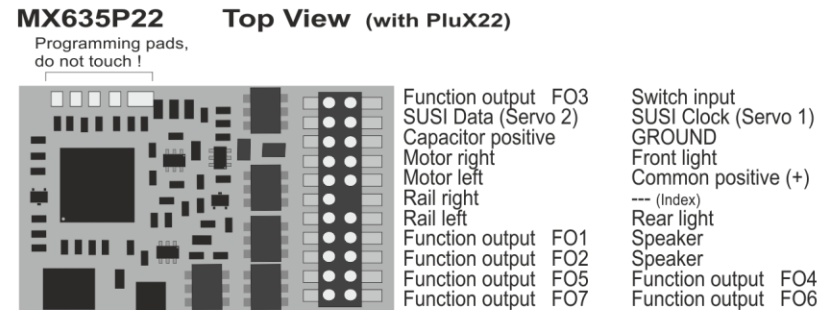
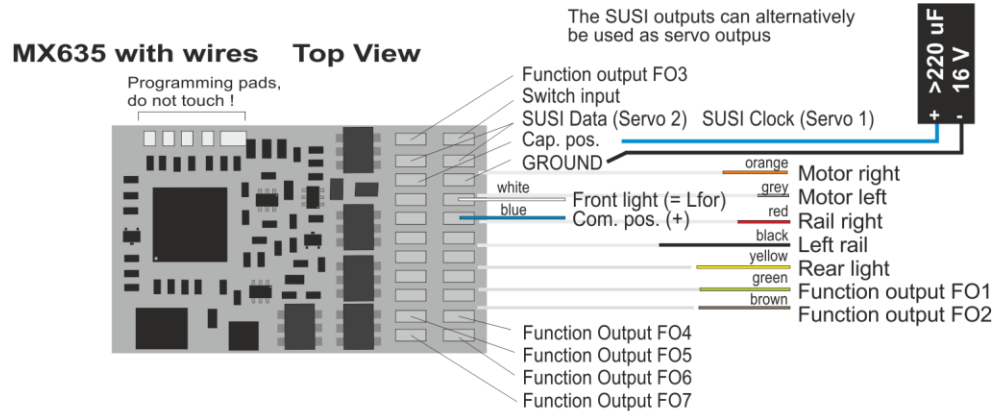
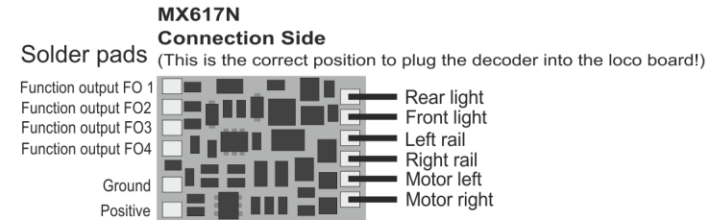
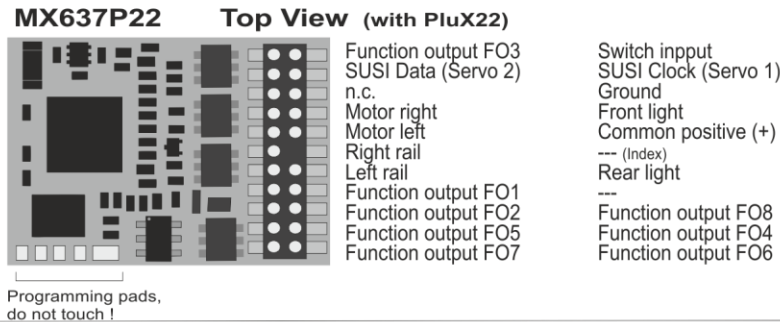
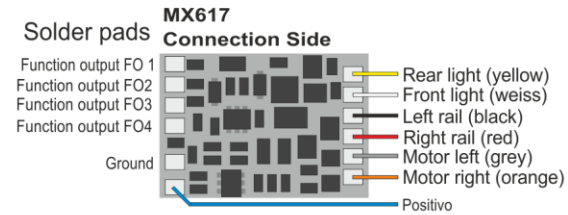
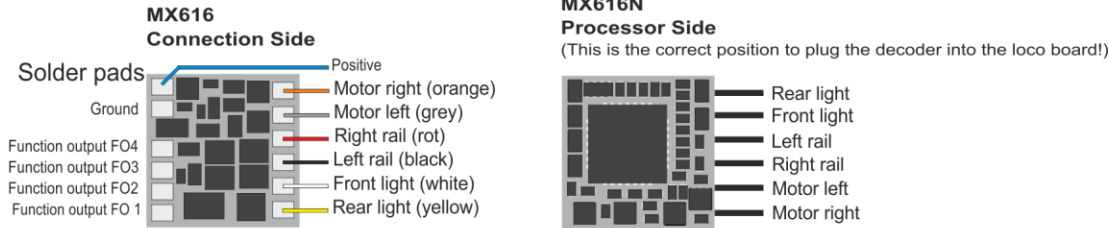

**MX638D, C Top View**

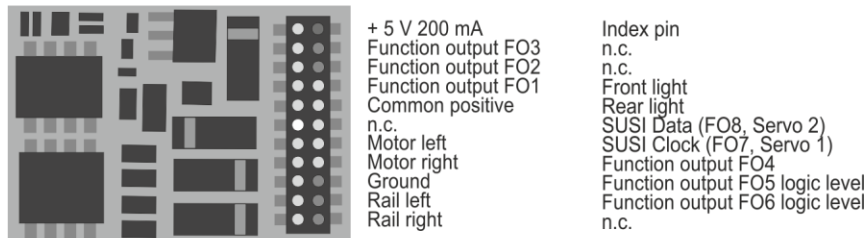

**MX659N18 Connector Side (Next 18)**

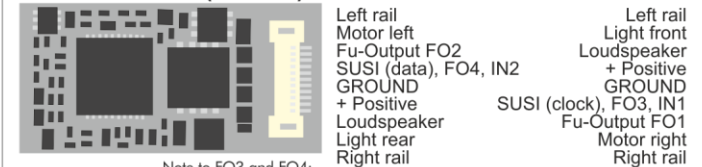

Note to FO3 and FO4:  
They are on the SUSI pins as logic level outputs when CV#124, Bit 7 = 1

Programming CV # 8 = 3 > converts MX634D to MX634C (outputs FO3, FO4 become logic-level outputs)  
 Programming CV # 8 = 4 > converts MX634C to MX634D (outputs FO3, FO4 become „normal“ (amplified) outputs)

**MX618N18**  
Connector Side (Next 18)

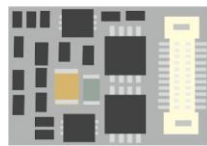

- |                    |                     |
|--------------------|---------------------|
| Left rail          | Left rail           |
| Motor left         | Light front         |
| Fu-Output FO2      | Fu-Output FO6       |
| SUSI (data) or FO4 | + Positive          |
| GROUND             | GROUND              |
| + Positive         | SUSI (clock) or FO3 |
| Fu-Output FO5      | Fu-output FO1       |
| Light rear         | Motor right         |
| Right rail         | Right rail          |

Note to FO3 and FO4: They are on the SUSI pins as logic level outputs when CV#124, Bit 7 = 1

Note FO5 and FO6 are logic level outputs only.

**MX622, MX622R, MX622F**  
(MX620 is similar)

Solder pads

- Function Output Fo2
- Function Output FO1
- Positive for "SUSI"
- "SUSI" CLOCK or FO3
- "SUSI" DATA or FO4
- GROUND

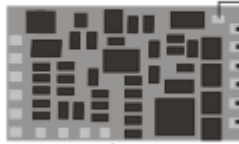

Programming pads, do not touch!

Wires

- Positive (blue)
- Motor (orange)
- Motor (gray)
- Rail (red)
- Rail (black)
- Front light (white)
- Rear light (yellow)

**MX620N or MX622N** (with 6-pin plug on board)  
Processor Side

(This is the correct position to plug the decoder into the loco board !)



- Rear light
- Front light
- Left rail
- Right rail
- Motor left
- Motor right

**MX600, MX600R** Wire side, top  
(single-layer board)

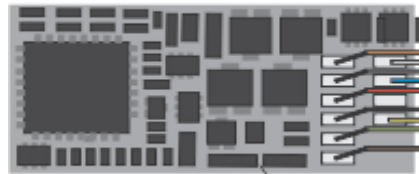

- Motor right (orange)
- Front headlight (= Lfor) white
- Motor left (gray)
- Common positive (blue)
- Right rail (red)
- Left rail (black)
- Front headlight (= Lrev) yellow
- Function output FO1 (green)
- Function output FO2 (brown)

Makeshift ground terminal if required between the diodes and the capacitor

**MX621, MX621R, MX621F**  
Wire side

Solder pads

- Function output FO1
- Function output FO2

Programming pads, do not touch!



Wires

- Positive (blue)
- Motor (orange)
- Motor (gray)
- Rail (red)
- Rail (black)
- Lfor (white)
- Lrev (yellow)

**MX621N** (= MX621 with 6-pin plug on board)  
Controller side

(this is also the correct installation position !)

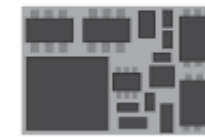

- Lrev
- Lfor
- Left rail
- Right rail
- Motor left
- Motor right

**MX623** Top View, wired side

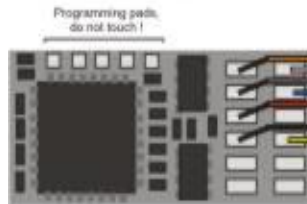

- Motor right (orange)
- Front headlight (= Lfor) white
- Motor left (gray)
- Common positive (blue)
- Right rail (red)
- Left rail (black)
- Rear headlight (= Lrev) yellow

**MX623** Top View, pin-out (PluX-12)

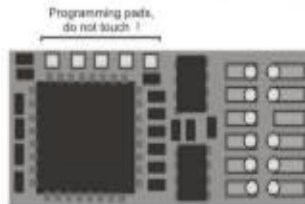

- Motor right
- Motor left
- Right rail
- Left rail
- Function outputs
- Function outputs

- Lfor
- Gem. Pluspol (+)
- 
- (Index)
- Lrev
- FO1
- FO3
- FO2
- FO4

FO3, FO4 are logic level outputs!

SUSI Clock or Servo 2, FO6

SUSI Data or Servo 1, FO5

**MX623** Bottom View



**MX630** Top View, wired side

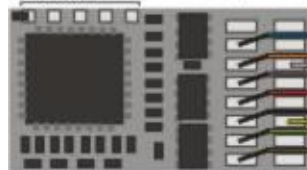

- Common positive (blue)
- Motor right (orange)
- Front headlight (= Lfor) white
- Motor left (gray)
- Right rail (red)
- Left rail (black)
- Rear headlight (= Lrev) yellow
- Function output FO1 (green)
- Function output FO2 (brown)

**MX630** Top View, pin-out



- SUSI, Servo's (2, 1) or FA6, FA5
- Common pos. (+)
- Motor right
- Motor left
- Right rail
- Left rail
- Function output
- Function output

- GROUND
- Lfor
- Common pos. (+)
- 
- (Index)
- Lrev
- FO1
- FO3
- FO2
- Fo4

**MX630P** (with PluX16)



- SUSI, Servo's (2, 1) or FO6, FO5
- Common pos. (+)
- Motor right
- Motor left
- Right rail
- Left rail
- Function output
- Function output

- GROUND
- Front light (= Lfor)
- Common pos. (+)
- 
- (Index)
- Rear light (= Lrev)
- FO1
- FO3
- FO2
- Fo4

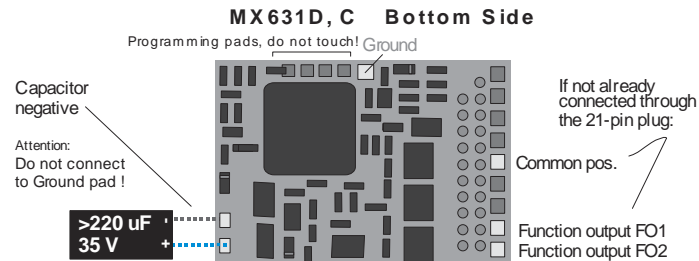
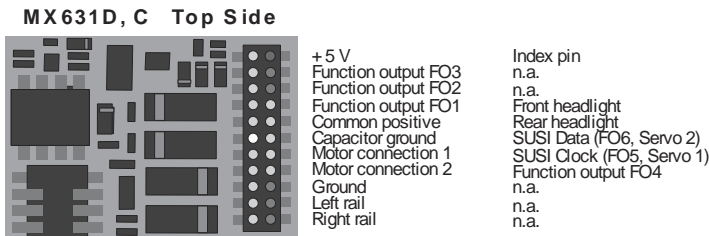
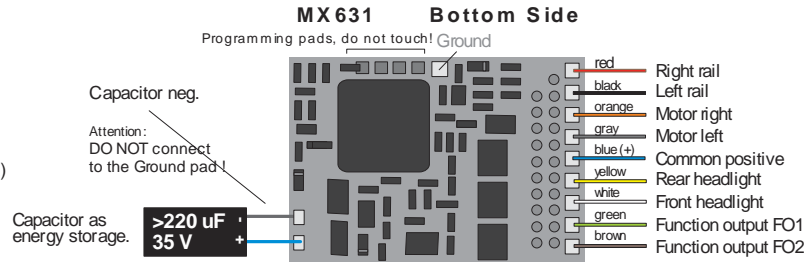
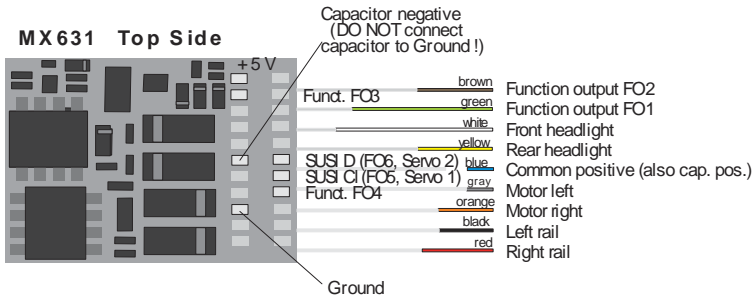

C versions differ from the D versions in the design of function outputs FO3 and FO4:

MX631D: FO3 and FO4 outputs are "normal" amplified outputs (same as headlights, FO1 etc.).

MX631C: FO3 and FO4 are logic level outputs.

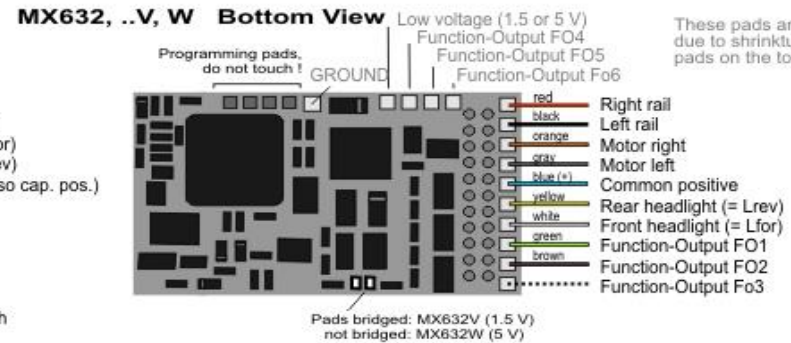
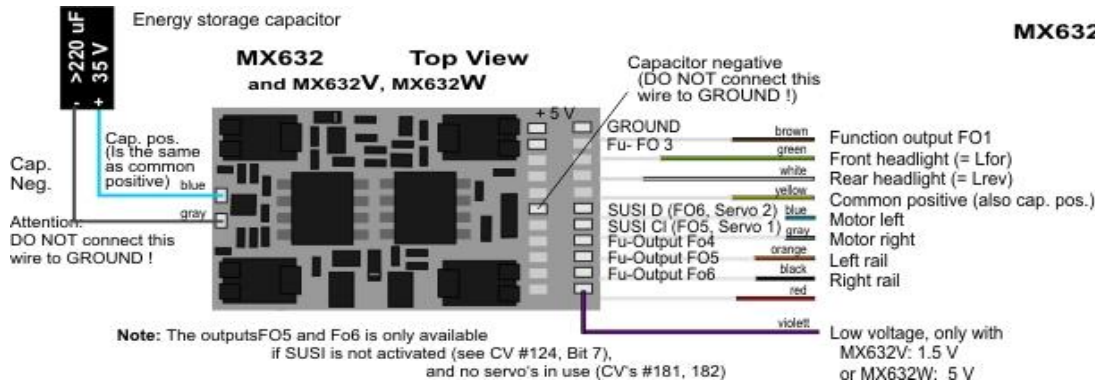

These pads are hard to reach due to shrinktube. Use the pads on the top side instead!

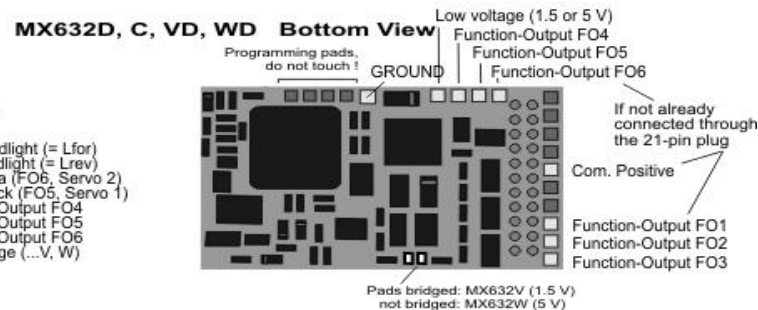
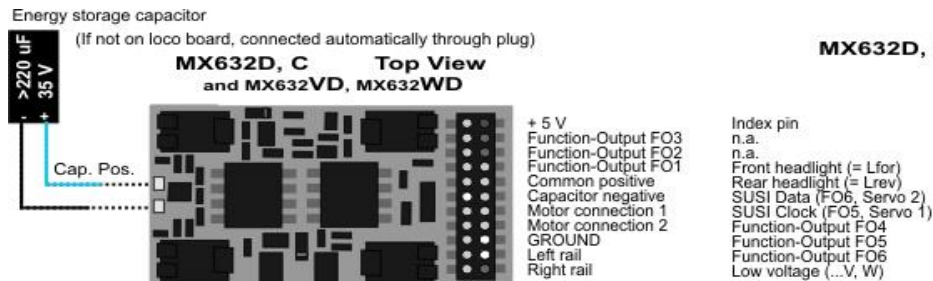

„C versions differ from the D versions in the design of function outputs FO3 and FO4:

MX631D: FO3 and FO4 outputs are "normal" amplified outputs (same as headlights, FO1 etc.).

MX631C: FO3 and FO4 are logic level outputs.



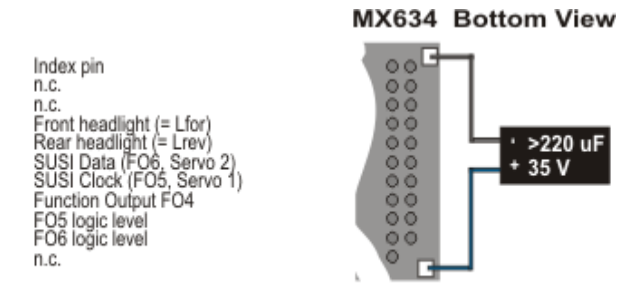
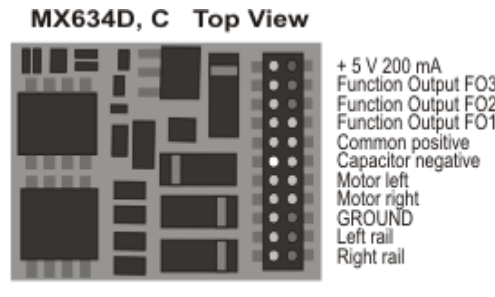
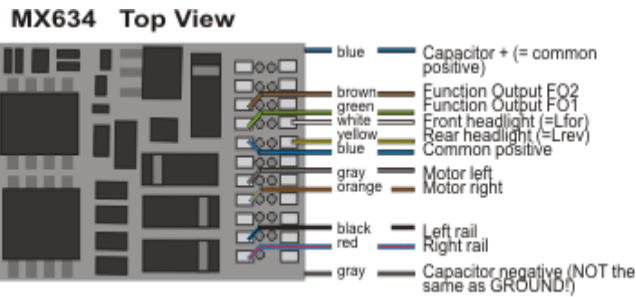
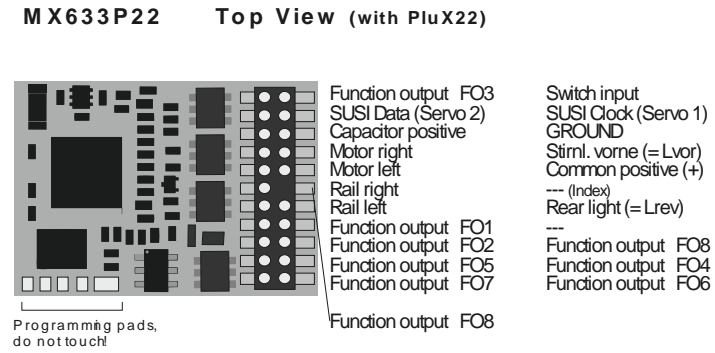
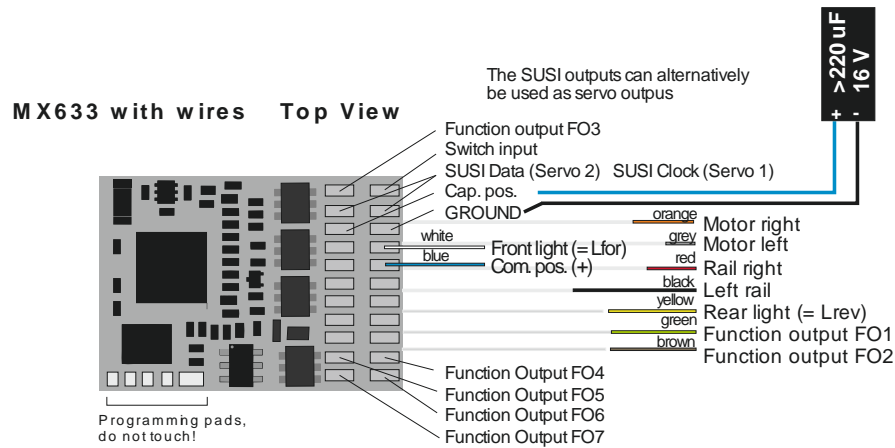

Programming CV #8 = 3 > converts MX634D to MX634C (Outputs FO3, FO4 become logic-level outputs)  
 Programming CV #8 = 4 > converts MX634C to MX634D (Outputs FO3, FO4 become "normal" (amplified) outputs)

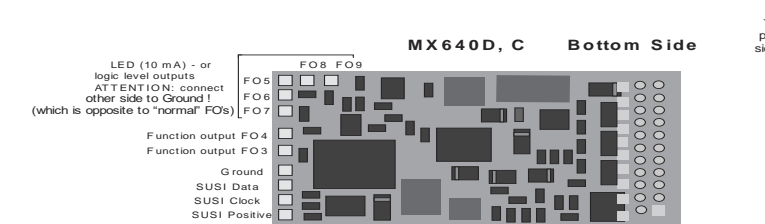
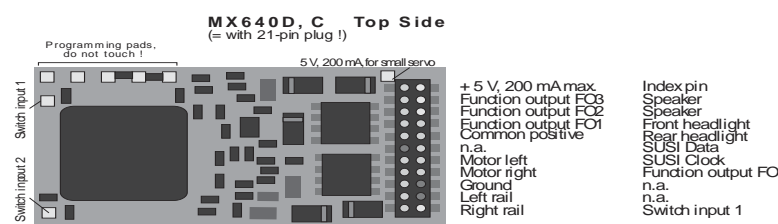
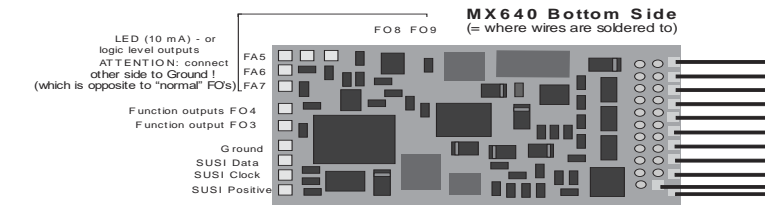
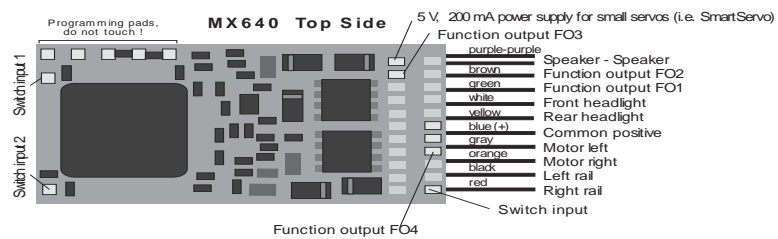

ATTENTION: The decoder can be plugged in from either side, depending on the circuit board in the locomotive.

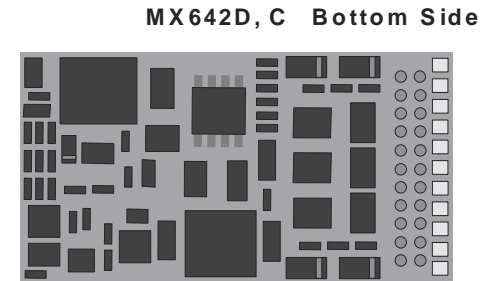
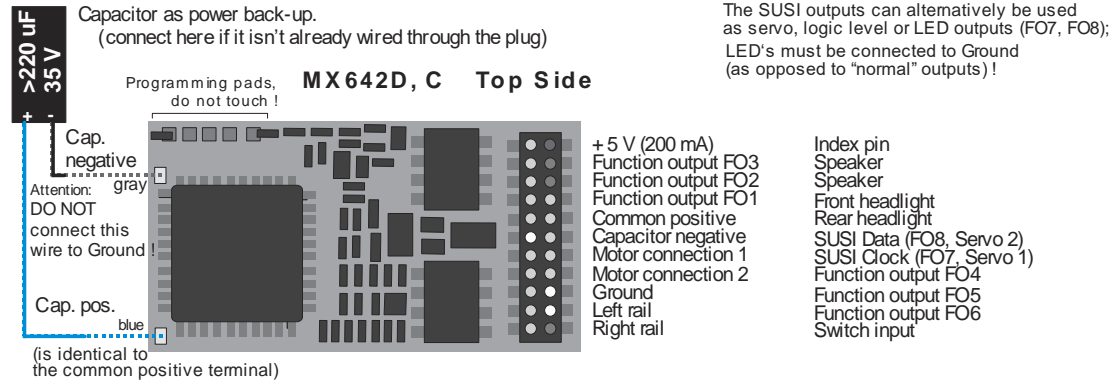
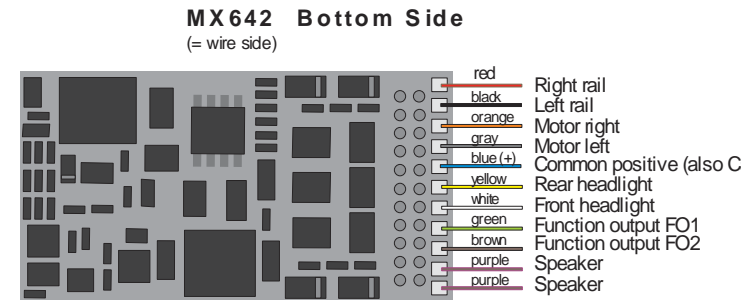
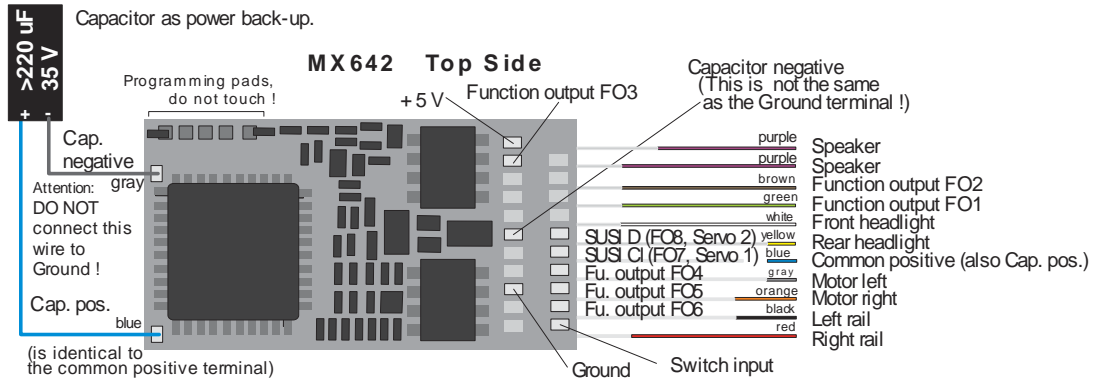

ATTENTION:  
The decoder can be plugged in from either side, depending on locomotive circuit board.

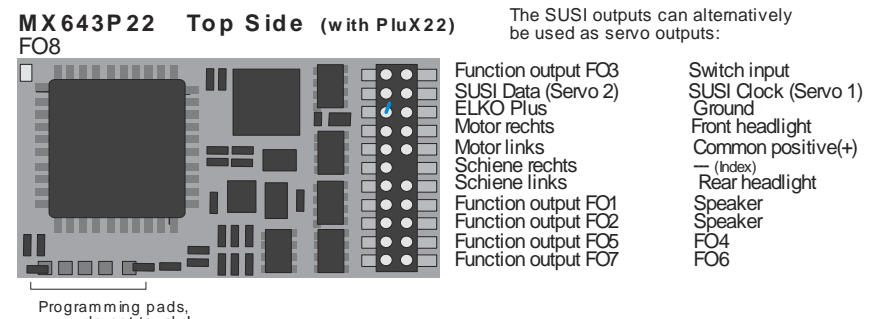
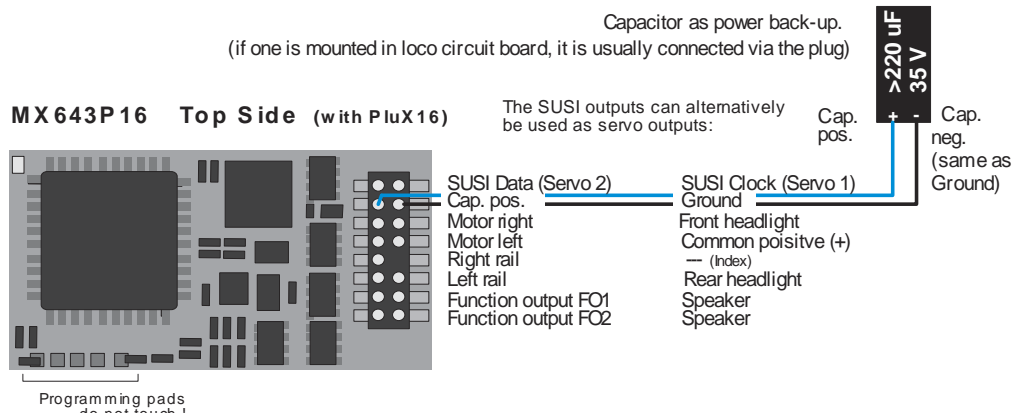

Total capacity of all connected capacitor must not exceed 5000uF. NO gold cap pack (GOLM...)!

MX644D, C Top View (with 21-pin „MTC“ connector)

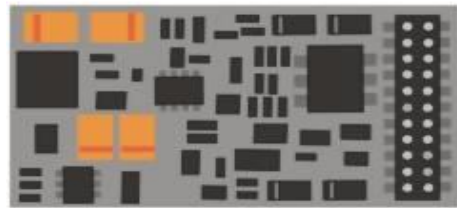

- + 5 V (200 mA)
- Function output FO3
- Function output FO2
- Function output FO1
- Common positive
- Capacitor negative
- Motor 1
- Motor 2
- GROUND
- Left rail
- Right rail
- GROUND
- Speaker
- Speaker
- Front headlight (= Lfor)
- Rear headlight (= Lrev)
- SUSI Data (FO8, Servo 2)
- SUSI Clock (FO7, Servo 1)
- Function output FO4
- Function output FO5
- Function output FO6
- Switch input

Fo3 and FO4 on the MX644C are logic level outputs, but "normal" outputs on the MX644D.



Capacitor as back-up power.  
(If not mounted on loco board and connected via plug)



Attention: CAP. neg. is not the same as GROUND!  
CAP. Neg. Gray

MX644D, C Bottom View

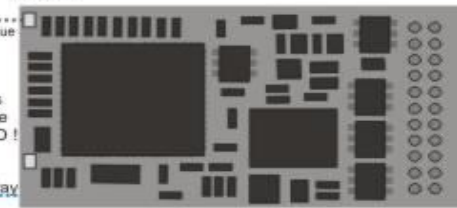

Attention: There are engines where the decoder must be plugged in normal (with the side top up) while on others it must be inserted upside down.

ATTENTION: Decoders installed by the loco manufacturer (OEM versions) may have fewer function outputs than shown here (i.e. only headlights, FO1, FO2), as the model requires.

Total capacity of all connected capacitor must not exceed 5000uF. NO gold cap pack (GOLM...)!

MX 645 wires only Top Side

Programming pads, do not touch!

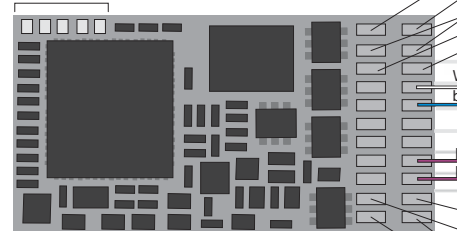

- Function output FO3
- Switch input
- SUSI Data (Servo 2) SUSI Clock (Servo 1)
- Cap. pos.
- Ground
- White
- blue
- Front headlight
- Common power (+)
- purple
- purple
- Speaker
- Speaker
- orange
- gray
- red
- black
- yellow
- green
- brown
- Motor right
- Motor left
- Right rail
- Left rail
- Rear headlight
- Function output FO1
- Function output FO2

The SUSI outputs can alternatively be used as servo outputs:



Cap. neg.  
Cap. pos.

MX 645 (all Types) Bottom Side

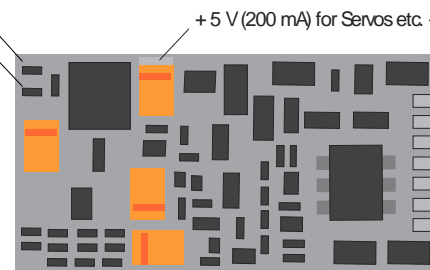

+ 5 V (200 mA) for Servos etc. – connect to tantalum

FO9 and FO10 are logic level outputs

Capacitor as power back-up.  
(is normally mounted on loco circuit board and connected via plug)

the same for MX645P22 and MX645P16.

Total capacity of all connected capacitor must not exceed 5000uF. NO gold cap pack (GOLM...)!

MX 645P 16 Top Side (with PluX16)

Programming pads, do not touch!

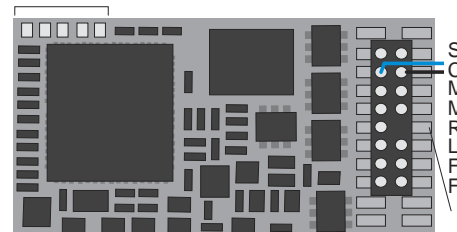

- SUSI Data (Servo 2)
- Cap. pos.
- Motor right
- Motor left
- Right rail
- Left rail
- Function output FO1
- Function output FO2
- Function output FO8
- SUSI Clock (Servo 1)
- Ground
- Front headlight
- Common positive (+)
- (Index)
- Rear headlight
- Speaker
- Speaker

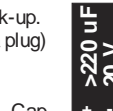

Cap. pos.  
Cap. negative (same as Ground)

The SUSI outputs can alternatively be used as servo outputs:

MX 645P 22 Top Side (with PluX22)

Programming pads, do not touch!

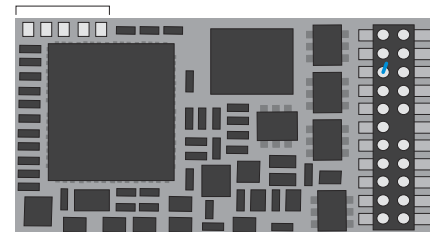

- Function output FO3
- SUSI Data (Servo 2)
- Capacitor positive
- Motor right
- Motor left
- Right rail
- Left rail
- Function output FO1
- Function output FO2
- Function output FO5
- Function output FO7
- Function output FO8
- Switch input
- SUSI Clock (Servo 1)
- Ground
- Front headlight
- Common positive (+)
- (Index)
- Rear headlight
- Speaker
- Speaker
- FO4
- FO6

The SUSI outputs can alternatively be used as servo outputs:

Also see chapter 7, "Loco or adapter boards"

**MX646, ..R, ..F Top Side**  
(= wire side)



**MX646, ..R, ..F Bottom Side**  
(= solder pad side)

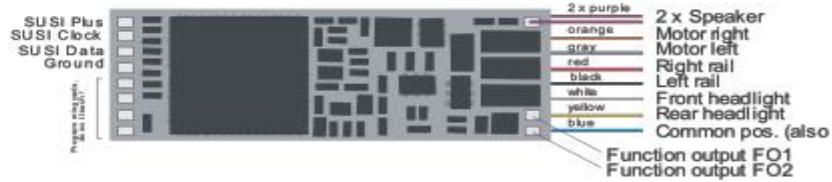

**MX646N, ..W Top Side**

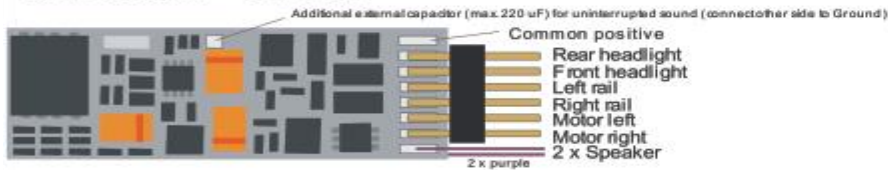

**MX646N, ..W Bottom Side**

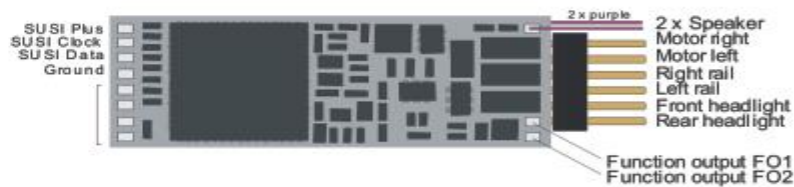

**MX649, ..R, ..F Top View**



**MX649N, ..L Top View**



**MX647N, ..W Top Side**



**Bottom Side**

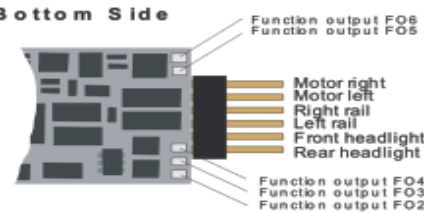

**MX658N18 Connector Side (Next 18)**

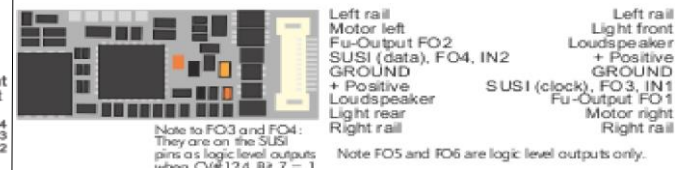

**MX648 Top View with wires**

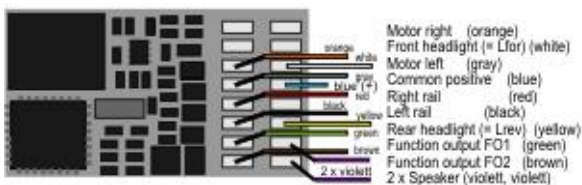

**MX648 Top Side pin-out**

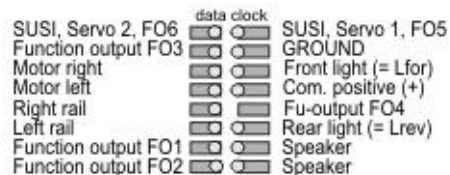

**MX648P (with PluX16)**

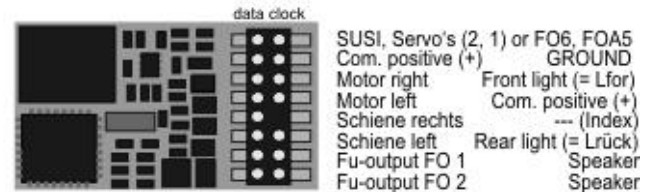

### 3 Address and CV Programming

ZIMO decoders can be programmed in

- **“Service Mode”** (on the **programming track**) for assigning a new address or reading and writing CV content, or in
- **“Operations Mode”** (a.k.a. “Programming on the main” or “PoM”), which is done on the main track; programming CV’s “on the main” is always possible in operations mode. However, an acknowledgement of successful programming steps or reading out CV’s is only possible with a RailCom capable DCC system.

**HELPFUL HINTS FOR CV PROGRAMMING:**

*If you are familiar with CV programming please skip this section and go directly to section 3.1!*

CV programming is not the same for all CV’s. While the programming procedure is the same for all CV’s, the calculation of the individual CV values varies.

For some CV’s it is obvious what the value is supposed to be and can easily be derived from the “Range” and/or “Description” column in the CV table. This kind of CV can be compared to volume control.

For instance, CV#2 determines the minimum speed applied at speed step 1:

CV	Denomination	Range	Default	Description
#2	Vstart	1 – 252 (See add. notes)	2	Entered value = internal speed step assigned to lowest cab speed step. Bit 4 in CV # 29 has to be 0; otherwise individual speed table is active.

The “range” column states that any value from 1 to 252 may be used. The higher the value the faster the engine runs at speed step 1 and vice versa.

Another similar CV is the “dimming” factor in CV #60:

CV	Denomination	Range	Default	Description
#60	Reduced function output voltage (Dimming)	0 - 255	0	The actual function output voltage can be reduced by PWM. Useful to dim headlights, for example. Example values: # 60 = 0 or 255: full voltage # 60 = 170: 2/3 of full voltage. # 60 = 204: 80% of full voltage.

Again, the range column states that any value from 1 to 252 may be used and in the “description” column it is explained that the brightness of the light increases with the value.

Other CV’s are easier to understand if you think of them as small switch boards, where you can turn individual switches ON or OFF. Such a CV is made up of 8 “individual switches” called Bits and the group of Bits is known as a Byte (which is the CV itself or the switch board, if you will). On some CV’s

you can change the setting of all 8 Bits (switches) and on others only a select few. The Bits (switches) are numbered from 0 to 7 and each has a specific value (**see the chapter “Converting binary to decimal”** for more on binary calculations). Each Bit is turned ON by adding its value to the CV and turned OFF by subtracting its value. Add up the values of each Bit you want to turn ON and enter the total to the CV.

One such CV is CV #29:

CV	Denomination	Range	Default	Description
#29	Basic configuration  CV #29 is calculated by adding the value of the individual bits that are to be “on”. Values to turn “on”: Bit 0: 1 Bit 1: 2 Bit 2: 4 Bit 3: 8 Bit 4: 16 Bit 5: 32 Bit 6: 64 Bit 7: 128	0 - 63	14	Bit 0 - Train direction: 0 = normal, 1 = reversed Bit 1 - Number of speed steps: 0 = 14, 1 = 28 Note: 128 speed steps are always active if corresponding information is received! Bit 2 - DC operation (analog): *) 0 = off 1 = on Bit 3 - RailCom („bidirectional communication”) 0 = deactivated 1 = activated see CV #28! Bit 4 - Individual speed table: 0 = off, CV # 2, 5, 6, are active. 1 = on, according to CV ’s # 67 – 94 Bit 5 - Decoder address: 0 = primary address as per CV #1 1 = ext. address as per CV #17+18 Bits 6 and 7 are to remain 0!
	ZIMO MX21, MX31... cabs also display the individual bits; calculating bit values is no longer necessary!			

As explained in the description column of that CV, you can only change Bit 0, 1, 2, 3, 4 and 5. Bits 6 and 7 have to remain OFF (0) because they are not yet used for anything. To calculate the total CV value you have to first look at the description field of that CV and determine which Bit (switch) you want to have ON. Let’s say we want speed steps 28 active, reverse the loco’s direction because it doesn’t agree with the cab’s direction indication and we want to use the individual speed table. This means we have to have the Bits 1, 0 and 4 turned ON (= 1). All other Bits can be OFF (= 0). In the “Denomination” field it shows the value for each Bit: Bit 0 = 1, Bit 1 = 2, Bit 2 = 4, Bit 3 = 8, Bit 4 = 16, Bit 5 = 32, Bit 6 = 64, and Bit 7 = 128. If we want to have Bits 1, 0 and 4 turned ON we add up the values for these Bits (2 + 1 + 16) and enter the total of 19 to CV #29.

Lastly there is a third kind of CV that sort of fits between the other two. Here you don't have to worry about Bits and their values. With those CV's the digit's position and value determines a specific action. Some of those digit positions act like a simple ON/OFF switch and others like a volume control.

For example, CV #56 can be used for fine-tuning a motor:

CV	Denomination	Range	Default	Description
#56	Back-EMF control P and I value	0 – 199 (See add. notes)	0 (is equal to 55, mid-range)  <b>But:</b> default is <b>not</b> suitable for <b>coreless motors, i.e. MAXXON, FAUL-HABER!</b>  Use "100" instead.	Back-EMF compensation is calculated by PID algorithm (Proportional/Integral - Differential); modifying these values may improve the compensation characteristics in certain cases.  0 - 99: for „normal“ DC motors (LGB etc.) 100 - 199: for coreless (MAXXON, Faulhaber, etc...)  Tens digit: Proportional (P) value; by default (0) is set to mid value and automatic adjustment with the goal of jerk free running. Proportional effect can be modified with settings of 1 – 4 and 6 – 10 (instead of the default 0 = 5).  Ones digit: Integral (I) value; is set by default to a mid-value. The Integral effect can be modified with settings of 1 – 9 instead of the default 0 = 5).

As you can see in the "Range" field you can use any number between 0 and 199. However if you read the "Description" field it explains that each digit position controls a specific function. In this case, the hundredth digit (\_xx) sets the decoder up for a coreless motor, the tens digit (x\_x) modifies the proportional and the ones digit (xx\_) the integral action. The hundredth digit acts just like a switch. If you use the hundredth digit (1\_) the coreless motor control is turned ON. If you don't use it (\_xx), the function is turned OFF. So for a normal DC motor you would only use the ones and tenth digit. With the tens digit (0 – 9) you can modify the proportional value and with the ones digit (0 – 9) the integral value.

Don't worry about the terms "proportional" or "integral" - just use the **"Step by step CV adjustment procedure"** later in the manual.

### 3.1 Programming in "Service mode" (on programming track)

The decoder must be unlocked, before it is possible to program, with

CV #144 = 0 or = 128 (the latter prevents decoder updating but allows programming).

This is normally the case (CV #144 = 0), but the programming lock is often activated in many sound projects to prevent accidental changes. It is therefore useful to check this CV, especially when programming attempts have already failed.

Acknowledgments of successful programming steps as well as CV read-outs on the programming track are accomplished by power pulses, which the decoder generates by briefly actuating the motor and/or headlights. If the motor and/or headlights do not draw power (i.e. they are not connected) or the power draw is too low, acknowledgments for successful programming or CV read-outs are not possible.

To make acknowledgments possible in such cases activate CV #112 bit 1, which enables the decoder to use an alternate acknowledgment method by sending high frequency pulses from the motor power amplifier. It depends on the digital system in use, if this procedure is successful or not.

CV	Denomination	Range	Default	Description
#144	Programming and Update Lock  Note: The programming lock has <b>no effect</b> on CV #144 and is therefore always accessible for unlocking.	Bits 6, 7	0 or 255	= 0: Decoder unlocked. Free programming and updating is possible.  Bit 6 = 1: Decoder programming in „Service Mode“ is blocked to prevent unwanted programming.  Note: Programming in "Operations Mode" is not locked because any such programming only applies to the active loco address and reprogramming the wrong locomotive is therefore not possible.  Bit 7 = 1: Software updates via MXDECUP, MX31ZL or other means are blocked.
#112	Special ZIMO configuration bits	0 - 255	4 = 00000100 that is Bit 1 = 0 (normal)	Bit 1 = 0: Normal acknowledgment in "Service Mode"; motor and headlight pulses.  = 1: High frequency pulses instead of normal acknowledgments from motor and headlights.  Bit 2 = 0: Loco number ID is OFF etc.

**Attention:** The CV values of sound decoders at time of delivery do not correspond with the default values in the following chapters, but rather the initial values of **each loaded sound project!**

This applies most often to

CV #29 – analog operation is usually turned off (Bit 3 = 0); CV #29 = 14 turns this on if desired.

CV #144 – the update lock may be activated (Bit 7 = 1), sometimes even the programming lock (Bit 6 = 1); before updating or programming a decoder, set this CV to CV #144 = 0.

CV #3, 4 – acceleration and deceleration CV's are often set to higher values (i.e. 12).

CV #33 and following – the functions are often mapped to a specific loco model...

...and of course the sound CV's (from CV #265) and (less frequently) all other CV's.

### 3.2 Programming in "Operational Mode" (on-the-main "PoM")

According to the current NMRA DCC standards, it should only be possible to program and read CV's on the main track, but not assign new vehicle addresses. However, certain DCC systems (among them ZIMO beginning with the system generation MX10/MX32) will allow addresses to be modified on the main track with the help of bidirectional communication.

All ZIMO decoders are equipped with bidirectional communication ("RailCom") and can therefore (with a corresponding DCC system such as ZIMO MX31ZL and all devices of the new MX10/MX32 generation) read, program and acknowledge successful CV programming steps in operations mode (on the main track). This requires RailCom to be activated, which is the case if the following CV's are set as:

**CV #29, Bit 3 = 1 (usually CV #29 = 14) AND CV #28 = 3**

This is usually the default setting, except in certain sound projects or OEM CV sets, where they need to be set prior to all other programming.

CV	Denomination	Range	Default	Description
#28	RailCom Configuration	0 - 3	3	Bit 0 - RailCom Channel 1 (Broadcast) 0 = OFF <b>1 = ON</b> Bit 1 - RailCom Channel 2 (Data) 0 = OFF <b>1 = ON</b>
#29	Basic settings	0 - 63	14 = 0000 1110 Bit 3 = 1 ("RailCom" is switched on) and Bits 1 & 2 = 1 (28 or 128 speed steps and DC operation enabled)	Bit 0 - Train direction: 0 = normal, 1 = reversed Bit 1 - Number of speed steps: 0 = 14, 1 = 28 Bit 2 - DC operation (analog): * 0 = disabled 1 = enabled Bit 3 - RailCom („bidirectional communication“) 0 = deactivated <b>1 = activated</b> Bit 4 - Individual speed table: 0 = off, CV # 2, 5 and 6 are active. 1 = on, according to CV 's # 67 – 94 Bit 5 - Decoder address: 0 = primary address as per CV #1 1 = ext. address as per CV #17&18

### 3.3 Decoder-ID, Load-Code, Decoder-Type and SW-Version

CV	Denomination	Range	Default	Description
#250, #251, #252, #253	Decoder-ID Also identifies decoder type with <b>CV #250 = Decoder type</b> (see chapter 2)	Read only	-	The decoder ID (serial number) is automatically entered during production: The first Byte (CV #250) denotes the decoder type; the three other Bytes contain the serial number. The decoder ID is primarily used for automatic address assignment when an engine is placed on the layout track (future function) as well is in conjunction with the "load code" for "coded" sound projects (see CV #260-

CV	Denomination	Range	Default	Description
#260, #261, #262, #263	"Load code" for "coded" sound projects	-	-	263). New ZIMO sound decoders can be ordered for a small fee with the "load code" pre-installed, which entitles the user to install "coded" sound projects of a selected sound bundle. The load code can also be purchased and installed by the user at a later date: see <a href="http://www.zimo.at">www.zimo.at</a> .
#8	Manufacturer ID and <b>HARD RESET</b> with CV #8 = 8 or CV #8 = 0 or Configure decoders as "C-type" or "D-type" (MX634 only): MX634D: FO3,FO4 = normal outputs MX634C: FO3,FO4 = logic level outputs  Activate Special CV Set	Read only	145 (= ZIMO)	Reading out this CV always result in "145" ("10010001"), the number issued for ZIMO by the NMRA. This CV is also used for various resetting processes with the help of Pseudo-Programming. Pseudo-Programming means that the entered value is not really stored, but rather used to start a defined action. <b>CV #8 = "3" → Converting a MX634D to MX634C</b> <b>CV #8 = "4" → Converting a MX634C to MX634D</b> <b>CV #8 = "8" → HARD RESET(NMRA standard);</b> all CV's return to the last active <b>CV set or sound project</b> , or the default values listed in this CV table if no such set was active before. CV #8 = "9" → <b>HARD RESET</b> for LGB-MZS operation (14 speed steps, pulse chain commands). Further options: see chapter "CV Sets"!
#7	SW-Version Number  Also see CV #65 for Sub-Version Number and special procedures for programming with "Lokmaus-2" and other "low level" systems	Read only	-	This CV holds the firmware version number currently in the decoder. With the help of "Pseudo-programming" it also helps to program decoders with DCC systems of limited range: Ones digit = 1: Subsequent programming value + 100 = 2: ... + 200 Tens digit = 1: Subsequent CV number + 100 = 2: ... + 200 etc. = 9: ... + 900 Hundreds digit = 0: Revaluation applies only once = 1: ... until power-off
#65	SW-Sub-Version Number Also see CV #7 for main version number	Read only	-	This CV indicates a possible sub-version number of a main version noted in CV #7. The entire SW version number is thus composed of CV #7 and #65 (i.e. 28.15).

### 3.4 The vehicle address(es) in DCC mode

Decoders are usually delivered with default **address 3 (CV #1 = 3)**, for the DCC as well as the MM (Märklin Motorola) format. All aspects of operations are possible with this address but it is recommended to change to a different address as soon as possible.

The address space required for DCC exceeds the range of a single CV, up to 10239 in fact. Addresses higher than 127 are stored in CV #17 and #18. Bit 5 in CV #29 is used to select between the short address in CV #1 and the long address in CV's #17/18.

☞ Most digital systems (with the possible exception of very old or simple products) automatically calculate the value for the CV's involved and also set Bit 5 in CV #29 to the proper value when writing the address, so that the user does not have to deal with the necessary coding.

CV	Denomination	Range	Default	Description
#1	Short Address	DCC: 1 - 127 MM: 1 - 80	3	The "short" (1-byte) loco address (DCC,MM) In the case of DCC: The address in CV #1 is only valid if CV #29, Bit 5 = 0. Otherwise, if CV #29 Bit 5 = 1, the long address in CV #17 + #18 applies.
#17 + #18	Extended (long) address	128 - 10239	0	The long DCC address applies to addresses >127. It is only active if CV #29 Bit5 = 1.
#29	Basic Configuration	0 - 63	14 = 0000 1110 with Bit 5 = 0 (for short address)	Bit 0 - Train direction: 0 = normal, 1 = reversed Bit 1 - Number of speed steps: 0 = 14, 1 = 28 Bit 2 - DC operation (analog): *) 0 = disabled 1 = enabled Bit 3 - RailCom („bidirectional communication") 0 = deactivated 1 = activated Bit 4 - Individual speed table: 0 = off, CV # 2, 5 and 6 are active. 1 = on, according to CV 's # 67 - 94 Bit 5 - Decoder address selection: 0 = short address as per CV #1 1 = long address as per CV #17+18

**Decoder-controlled consisting (a.k.a. "Advanced consisting")**

The combined operation of two or more locomotives (consisting) can be managed by

- the DCC system (common practice with ZIMO systems, without changing any decoder CV's) or
- by programming the following decoder CV's individually, but can also be managed by some DCC systems (often the case with American made systems).

This chapter only covers the decoder-controlled consisting!

CV	Denomination	Range	Default	Description
#19	Consist address	0, 1 - 127 129 - 255 (= 1 - 127 with inverted direction)	0	A common consist address for 2 or more engines can be entered in this CV to each loco of the same consist. If CV #19 > 0: Speed and direction is governed by this consist address (not the individual address in CV #1 or #17&18); functions are controlled by either the consist address or individual address, see CV's #21 & 22.

CV	Denomination	Range	Default	Description
				Bit 7 = 1: Driving direction reversed
#20	Extended consist address From SW version 36.6	0 - 102	0	The value of CV20 multiplied with 100 added together with the value of CV 19 which result is the address at consist. e.g. CV20= 12, CV19=34 is address. 1234 CV20=100, CV19=00 is address 10000
#21	Consist functions F1 - F8	0 - 255	0	Functions so defined here will be controlled by the consist address. Bit 0 = 0: F1 controlled by individual address = 1: .... by consist address Bit 1 = 0: F2 controlled by individual address = 1: .... by consist address ..... F3, F4, F5, F6, F7 Bit 7 = 0: F8 controlled by individual address = 1: .... by consist address
#22	Consist Functions F9 – F27 and headlight control	0 - 191	0	Select whether the headlights are controlled with the consist address or individual address. Bit 0 = 0: F0 (forw.) controlled by individual address = 1: .... by consist address Bit 1 = 0: F0 (rev.) controlled by individual address = 1: .... by consist address Bit 2 = 0: F9 controlled by individual address = 1: .... by consist address Bit 3 = 0: F10 controlled by individual address = 1: .... by consist address Bit 4 = 0: F11 controlled by individual address = 1: .... by consist address Bit 5 = 0: F12 controlled by individual address = 1: .... by consist address Bit 7 = 1: F13 – F27 (all!) ....by consist address Bit 6 = 1: <b>SW-Version 37.0 and later!</b> Auto-Consist: The system changes automatically between individual and consist address, if one of the two addresses has speed 0 and the other has speed >0.

**3.5 Analog operation**

All ZIMO decoders are capable of operating on conventional layouts with DC power packs, including PWM throttles, in **analog DC** as well as in **analog AC** (Märklin transformers with high voltage pulse for direction change).

To allow analog operation

**CV #29, Bit 2 = 1**

must be set. This is usually the case by default (CV #29 = 14, which includes Bit 2 = 1), but analog operation may be turned off in many sound projects (sound decoders). **It is recommended to turn analog mode off when operating strictly on DCC!**

The actual behavior during analog operation, however, is strongly influenced by the locomotive controller (power pack). Especially in conjunction with a weak transformer, it is easily possible that the



track voltage collapses when the decoder (motor) starts to draw power which, in the worst case, may lead to intermittent performance.

There are some adjustment possibilities for analog operation where motor control and function outputs are concerned; these CV's can of course be read-out or programmed only with a DCC system or other programming device.

CV	Denomination	Range	Default	Description
#29	Basic Configuration	0 - 63	14 = 0000 1110  Bit 2 = 1 (enables analog operation)	Bit 0 - Train direction: 0 = normal, 1 = reversed Bit 1 - Number of speed steps: 0 = 14, 1 = 28 Bit 2 – Automatic DC operation (analog): * 0 = disabled 1 = enabled Bit 3 - RailCom („bidirectional communication“) 0 = deactivated 1 = activated Bit 4 - Individual speed table: 0 = off, CV # 2, 5 and 6 are active. 1 = on, according to CV 's # 67 – 94 Bit 5 - Decoder address selection: 0 = short address as per CV #1 1 = long address as per CV #17+18
#13	Analog functions F1...F8	0 - 255	0	Defines functions that should be “ON” in analog mode. Bit 0 = 0: F1 is OFF in analog mode = 1: ...ON in analog mode Bit 1 = 0: F2 is OFF in analog mode Bit 1 = 1: ...ON in analog mode .....F3, F4, F5, F6, F7 Bit 7 = 0: F8 is OFF in analog mode Bit 7 = 1: ...ON in analog mode
#14	Analog functions F0 v&r, F9 – F12, Analog momentum and Regulated Analog	0 - 255	64 (equals Bit 6 = 1)	Defines function outputs that should be “ON” in analog mode. Bit 0 = 0: F0 (forw) is OFF in analog mode = 1: ...ON in analog mode Bit 1 = 0: F0 (rev) is OFF in analog mode Bit 1 = 1: ...ON in analog mode Bit 2 = 0: F9 is OFF in analog mode Bit 2 = 1: ...ON in analog mode -----F10, F11, F12 Bit 6 = 0: Analog operation with acceleration and deceleration according to CV #3 and #4, especially useful for sound Bit 6 = 1: Analog operation without acceleration and deceleration according to CV #3 and #4. Bit 7 = 0: unregulated DC operation Bit 7 = 1: regulated DC operation

Note: Actual decoder settings may differ from the default values if a sound project is on the decoder; in particular, the motor regulation (CV #14, Bit 7) is often enabled. The regulation only works well with power packs that apply “clean” DC voltage (i.e. with an LGB 50 080); otherwise it is better to turn the motor regulation off.

### 3.6 Motor Regulation

#### The speed curve

There are two types of speed curves, which are selected with

CV #29, Bit 4 = 0: 3-step curve (defined by 3 CV's)

... = 1: 28-step curve (defined by 28 CV's)

**3-point speed table:** the lowest, highest and medium speed is defined by the Configuration Variables #2 (Vstart), #5 (Vhigh) and #6 (Vmid) (=external speed step defined by slider position). This is a simple way to quickly establish a speed range and its curvature.

The three-step curve is usually sufficient.

**28-point speed table (a.k.a. "free programmable speed table"):** with the help of CV's #67 - 94, all 28 external speed steps can be freely assigned to the 128 internal speed steps. These 28 CV's apply to all speed step modes (14, 28 and 128). If 128 external speed steps are used, the decoder adds the missing intermediate values by interpolation.

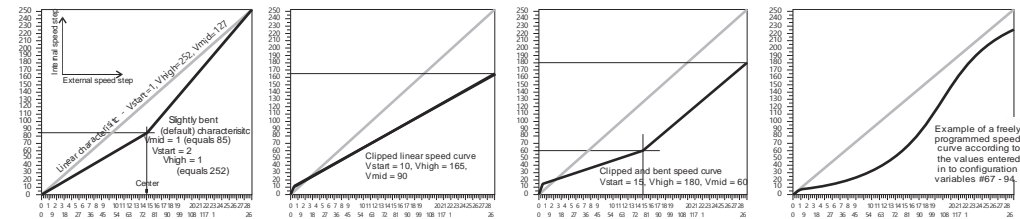

CV	Denomination	Range	Default	Description
#2	Start Voltage Vstart	1 - 255	1	Internal speed step (1 ... 255) applied as <b>lowest</b> external speed step (= speed step 1) (applies to 14, 28, or 128 speed step modes) = 1: lowest possible speed
#5	Top Speed Vhigh	0 - 255	0, 1 corresponds to 255	Internal speed step (1 ... 255) applied as <b>highest</b> external speed step (14, 25 or 128, depending on the speed step mode selected in CV # 29, Bit 1) =0 = 1 (same as 255): fastest top speed possible.

CV	Denomination	Range	Default	Description
#6	Medium Speed Vmid	1, ¼ to ½ of the value in CV #5	1  (= @ 1/3 of top speed)	Internal speed step (1 ... 255) applied as <b>medium</b> external speed step (that is, speed step 7, 14 or 64 depending on the speed step mode se- lected in CV #29, Bit 1) "1" = default (Medium speed is set to one third of top speed. I.e., if CV #5 = 255 the curve is the same as if CV #6 would be programmed to 85). The speed curve resulting from CV #2, 5 and 6 is au- tomatically smoothed out.
#29	Basic configuration	0 - 63	14 = 0000 1110 with Bit 4 = 0 (3-speed step)	Bit 0 - Train direction: 0 = normal, 1 = reversed Bit 1 - Number of speed steps: 0 = 14, 1 = 28/128 Bit 2 - DC operation (analog): *) 0 = disabled 1 = enabled Bit 3 - RailCom („bidirectional communication“) 0 = deactivated 1 = activated Bit 4 - Individual speed table: 0 = off, CV # 2, 5 and 6 are active. 1 = on, according to CV 's # 67 – 94 Bit 5 - Decoder address: 0 = primary address as per CV #1 1 = ext. address as per CV #17+18
#67 ..... #94	Individual speed table, if CV #29, Bit 4 = 1	0 - 255	*)	User programmable speed table. Each CV corresponds to one of the 28 external speed steps that can be "mapped" to internal steps (1 – 255). *) The 28-point default curve is also bent in the lower speed range.
#66 #95	Directional speed trimming	0 - 255 0 - 255	0 0	Speed step multiplication by "n/128" (n is the trim value in this CV) #66: for forward direction #95: for reverse direction

### The reference voltage for motor regulation

CV # 57 specifies the base voltage used for motor regulation. For example: if 14V is selected (CV value: 140) the decoder tries to send the exact fraction of this voltage, determined by the speed regulator position, to the motor, regardless of the voltage level at the track. As a result the speed remains constant even if the track voltage fluctuates, provided the track voltage (more precisely, the rectified and processed voltage inside the decoder, which is about 2V lower) doesn't fall below the absolute reference voltage.

The default value "0" in CV #57 selects the "relative reference", which automatically adjusts the reference voltage to the available track voltage. This setting is only useful if the system can keep the track voltage constant at all times (stabilized track output) and the resistance along the track kept to a minimum. All ZIMO systems keep the track voltage stable even older systems, but not every system from other manufacturers do, especially the relatively cheap systems built before 2005. It is not recommend-

ed to set CV #57 to "0" with systems that don't keep track voltage stabilized. Instead set this CV about 2V below track voltage (i.e. 140 for 16V).

CV #57 can also be used as an alternative to CV #5 (top speed), which has the advantage that the full resolution of the 255 speed steps remains available.

CV	Denomination	Range	Default	Description
#57	Voltage reference	0 - 255	0	Absolute voltage in tenth of a volt applied to the motor at full speed (max. throttle setting). Example: A system from another manufacturer is set to 22V at idle but drops to 16V under load: A good setting would be CV #57 = 140...150. CV #57 = 0: automatically adjusts to the track voltage (relative reference); only useful with stabilized track voltage.

### Tweaking the motor regulation

The motor's performance, especially at crawling speeds (as judder-free as possible), can be fine-tuned with the following CV's:

#### CV #9 – Motor control frequency and EMF sampling rate

The motor is controlled by pulse with modulation that can take place at either low or high frequency.

Low frequency (30 – 159Hz) is only useful for very few locomotives with very old motors (i.e. AC motors with field coils instead of permanent magnets).

**High frequency (20 kHz by default, up to 40 kHz as per CV #112)** on the other hand is **quiet and easy on the motor**.

Power to the motor is interrupted periodically (50 – 200 times/sec.), even when operating at high frequency, in order to determine the current speed by measuring back-EMF (voltage generated by the motor). The more frequent this interruption takes place (sampling rate), the better; but that also causes power loss and increased noise. By default, the sampling frequency varies automatically between 200Hz at low speed and 50 Hz at maximum speed.

CV #9 allows the adjustment of the sampling frequency (tens digits) as well as the sampling time (ones digits). The default value of 55 represents a medium setting.

#### CV # 56 – The PID regulation

The motor regulation can be tailored to motor type, vehicle weight and so on, by using different *Proportional-Integral-Differential* values. In reality, changing the differential value can be omitted.

CV #56 allows the proportional value (tens digit) as well as the integral value (ones digit) to be set individually. The default value of 55 represents a medium setting.

CV	Denomination	Range	Default	Description
#9	Motor control frequency and EMF sampling (Algorithm)	55 High frequency, medium sampling	55 High frequency, medium scanning	= 55: Default motor control with high frequency (20/40kHz), medium EMF sampling rate that automatically adjusts between 200Hz (low speed) and 50Hz and medium EMF sampling time. <-> 55: Modification of automatic adjustments with:



CV	Denomination	Range	Default	Description
#58	BEMF intensity	0 - 255	255	Intensity of back-EMF control at the lowest speed step. If required, an "intensity curve" can be achieved using CV #10, 58 and 113 to reduce load regulation at higher speeds. <u>Example:</u> # 58 = 0: no back-EMF # 58 = 150: medium compensation, # 58 = 255: maximum compensation.
#10	Compensation cut-off <small>This CV is seldom required</small>	0 - 252	0	Assigns an internal speed step where back EMF intensity is reduced to the level defined in CV #113. CV #10, #58 and #113 together define a back-EMF curve. = 0: default curve is valid (as in CV #58).
#113	Compensation cut-off <small>This CV is seldom required</small>	0 - 255	0	The BEMF intensity is reduced to this value at the speed step defined in CV #10. CV #113 together with CV's #58 and #10 form a 3-point BEMF curve. = 0: actual cutoff at speed step in CV #10. Usually CV #10 is also set to 0.
#145 #147 #148 #149 #150	Experimental CV's for test purposes,  to find out whether certain automatic settings have a negative effect on motor regulation. Using these experimental CV's will deactivate the automatic settings.  CV's #147 - 149 will likely be removed again from the decoder SW at some time.  <b>CV #145 = 10,11,12,13 for C-Sinus motors</b> See chapter 6 (Installation)		0 0 0 0 0	--- CV #145 = 1: Special setting for Fleischmann round motor. --- CV #147 Sampling time --- Useful initial value: 20; Too small a value leads to jerky behavior. Too large a value leads to poor low speed control. 0= automatic control (CV #147 has no effect) --- CV #148 D-Value --- Useful initial value: 20; Too small a value leads to poor regulation (regulates too little, too slow, engine judders (rather slowly)). Too large a value leads to over compensation, the engine runs rough/vibrates. 0 = automatic control (CV #148 has no effect) --- CV #149 P-Value --- 0 = automatic control (CV #149 has no effect) 1 = P-Value is fixed as per CV #56 (tens digit) --- CV #150 Load compensation at top speed --- Load compensation at top speed is normally always 0. This can be changed with CV #150.  Example: CV #58 = 200, CV #10 = 100, CV #113 = 80 und CV #150 = 40 --> Result: Regulation at speed step 1 is 200 (of 255, almost 100%), at speed step 100 it is 80 (@1/3 <sup>rd</sup> of 255), at speed step 252 (full speed) it is 200 (of 255, almost fully regulated). <b>We kindly ask for your cooperation. Please send us your test results!</b>

### The Motor Brake

This brake is useful for vehicles without worm gears to prevent them from rolling away on inclines, picking up speed on declines as well as to prevent a heavy train from pushing a standing engine downhill.

CV	Denomination	Range	Default	Description
#151	Motor brake	0 - 99	0	= 0: brake not active Ones digit: 1 - 9: The motor brake is gradually actuated (over a period of 1, 2 ... 8 seconds, up to full braking power by shorting both motor power amplifier) if target speed is not reached (not slowing down) after cutting power to the motor (Zero PWM to the motor). The higher the value, the faster and harder the brake is being applied. Tens digit: 1-9: Reduction of the motor regulation if consist-key is active. The values 1-9 reduce the control to 10%-90% of the value set in CV #58.

### 3.7 Acceleration and Deceleration:

The basic acceleration and deceleration times (momentum) are set with

#### CV's #3 and #4

according to the relevant NMRA standard, which demands a linear progression (the time between speed step changes remains constant over the whole speed range). For simple smooth drivability use values 3 or higher but for really slow starts and stops start with a value of 5. Values over 30 are usually impractical!

Acceleration and deceleration behavior, especially starting and stopping, can be further improved by the "exponential" and "adaptive" acceleration/deceleration features (CV's #121, 122 and 123).

☞ The sound project in sound decoders always comes with different values in CV's #3 and #4 (as well as many other CV's) than what is listed in the CV charts. Often the sound can only be played back correctly in conjunction with the acceleration times provided by the sound project (or certain minimum values), so the sound project's default values should therefore not be changed too much.

To eliminate a start-up jolt after changing the direction, caused by gear backlash in gearboxes, use CV #146: Some free play between gears of a drivetrain is essential to prevent them from binding. This creates backlash and may be more severe on some engines than on others, especially when fitted with a worm gear or an excessively worn gearbox.

CV	Denomination	Range	Default	Description
#3	Acceleration rate	0 - 255	(2)	The value multiplied by 0.9 equals' acceleration time in seconds from stop to full speed. The effective default value for sound decoders is usually not the value given here, but is determined by the loaded sound project.

CV	Denomination	Range	Default	Description
#4	Deceleration rate	0 - 255	(1)	The value multiplied by 0.9 equals' deceleration time in seconds from full speed to a complete stop. The effective default value for sound decoders is usually not the value given here, but is determined by the loaded sound project.
#23	Acceleration trimming	0 - 255	0	To temporarily adapt the acceleration rate to a new load or when used in a consist. Bit 0 - 6: entered value increases or decreases acceleration time in CV #3. Bit 7 = 0: adds above value to CV #3. = 1: subtracts above value from CV #3.
#24	Deceleration trimming	0 - 255	0	To temporarily adapt the deceleration rate to a new load or when used in a consist. Bit 0 - 6: entered value increases or decreases deceleration time in CV #4. Bit 7 = 0: adds above value to CV #4. = 1: subtracts above value from CV #4.
#121	Exponential acceleration	0 - 99	0	Acceleration time (momentum) can be stretched in the lower speed range: Tens digit: Percentage of speed range to be included (0 to 90%). Ones digit: Exponential curve (0 to 9). <u>EXAMPLE:</u> CV #121 = 11, 23 or 25 are typical initial test values.
#122	Exponential deceleration	0 - 99	0	Deceleration time (momentum) can be stretched in the lower speed range: Tens digit: Percentage of speed range to be included (0 to 90%). Ones digit: Exponential curve (0 to 9). <u>EXAMPLE:</u> CV #122 = 11, 23 or 25 are typical initial test values.
#123	Adaptive acceleration and deceleration	0 - 99	0	Raising or lowering the speed to the next internal step occurs only if the preceding step is nearly reached. The tolerance for reaching the preceding step can be defined by this CV (the smaller this value the smoother the acceleration/deceleration). Value 0 = no adaptive accel. or decel. Tens digit: 0 - 9 for acceleration (1 = strong effect) Ones digit: 0 - 9 for deceleration <u>EXAMPLE:</u> CV #123 = 11: strongest effect; sometimes affects the start up too much. CV #123 = 22: typical setting.
#394	Bit 4: Faster acceleration From SW-Version 33.25	0 - 255	-	Bit 0 = 1: Light flashes at switchgear sound.. Bit 4 = 1: Accelerates faster and sets sound to high load when regulator is moved quickly to full speed Bit 5 = 1: Blending of chuff samples

CV	Denomination	Range	Default	Description
#309	Brake key From SW-Version 33.25	0 - 29	0	The key defined here acts as a brake key according to the rate defined in CV #349 (the normal – higher – deceleration time in CV #4 is thereby ignored).
#349	Brake time From SW-Version 33.25	0 - 255	0	To achieve the desired effect, the deceleration time in CV #4 must be set to a very high value (@ 50 ... 250) but the brake time in CV #349 rather low (5 ... 20). This simulates a coasting effect with the “regulator at 0”, while the brake key results in a short stopping distance.
#146	Compensation for gear backlash during direction changes in order to reduce start-up jolt. NOT for MX621	0 - 255	0	= 0: no effect = 1 to 255: the motor spins at minimum rpm (according to CV #2) for a specific time and only starts to accelerate after this time has elapsed. This CV will only be executed after a direction change. How much time is required to overcome the backlash depends on various circumstances and can only be determined by trial and error. Typical values are: = 100: the motor turns about 1 revolution or a maximum of 1 second at the minimum speed. = 50: about ½ a turn or max. ½ second. = 200: about 2 turns or max. 2 seconds. Important: The minimum speed must be set correctly, so that the motor actually turns at the speed step defined as the lowest step in CV #2. Also, CV #146 is only useful if the load regulation is set to maximum or at least close to it (i.e. CV #58 = 200 – 255).

NOTE: The actual acceleration and deceleration rates for HLU brake sections (ZIMO signal controlled speed influence) are determined by CV #49 and #50.

**Momentum – explained in more detail:**

The momentum (acceleration and deceleration rates) according to CV #3 and #4 refers to the 255 internal steps which are spaced equally from 0 to full speed. The selected speed table, whether 3-step or 28-step, does not influence the momentum behavior.

The momentum CANNOT be embettered by bending the speed curve in the speed tables, but is very much possible with the “exponential acceleration/deceleration” in CV #121 and #122.

### 3.8 Special Operating Mode “km/h – speed regulation”

The km/h speed regulation is an alternative method of driving with prototypical speeds in all operating situations: the cab’s speed steps (1 to 126 in the so-called “128 speed step mode”) will be directly interpreted as km/h.

However, ZIMO decoders do not simply convert the speed steps to a km/h scale but rather ensure that the desired speed is held, by recalculating the already traveled distance and automatically make the necessary adjustments.

#### A CALIBRATION RUN must be performed with each engine:

First, we need to determine the **calibration distance**: a section of track that measures 100 scale meters (plus the necessary acceleration and deceleration distances before and after), of course without inclines, tight radii and other obstacles; for example, for HO (1:87) 115cm; for G-scale (1:22.5) 4.5m. Mark the start and end points of the calibration section.

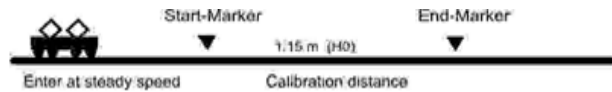

→ Set the engine on the track, with the proper travel direction selected, about 1 to 2 meters before the start marker and the function F0 (headlights) **turned off**. Acceleration times (in CV #3 of the decoder as well as settings in the cab) should be set to 0 or a very small value.

→ Start the calibration mode by programming **CV #135 = 1** (operational mode programming). This is a pseudo-programming because the value of 1 does not replace the value already stored in CV #135.

→ Move the speed regulator to a **medium speed** position (1/3 to 1/2 of full speed); the loco accelerates towards the start marker

→ As the engine passes the **start marker**, **turn on** the function **F0** (headlights); **turn F0 off** again when passing by the **end marker**. This ends the calibration run and the loco may be stopped.

→ CV #136 can now be read out for checking purposes. The calibration “result” stored in that CV doesn’t mean very much by itself. If however, several calibration runs are performed, the value in CV #136 should approximately be the same every time, even if the traveling speed was different.

#### Km/h speed regulation in operation:

**CV #135** defines whether the “normal” or km/h operating mode is in use:

CV #135 = 0: The engine is controlled in “normal” mode; a possible km/h calibration run performed earlier has no effect but the calibration results remain stored in CV #136.

CV #135 = 10, 20 or 5: each external speed step (1 to 126) becomes  
1 km/h, 2 km/h or 0.5 km/h: see CV table below!

The speed regulation in km/h is not just useful for direct throttle control, but also for speed limits through the “signal controlled speed influence” (CV’s #51 – #55). The values entered to those CV’s are also being interpreted in km/h.

CV	Denomination	Range	Default	Description
#135	Km/h – Speed regulation - Activation, control and range definition <b>NOT applicable to MX621</b>	2 - 20	0	= 0: km/h – Regulation turned off; the “normal” speed regulation is in effect. Pseudo-Programming: CV #135 = 1 → Initiates a calibration run (see above) Continue with “normal” programming: = 10: each step (1 to 126) represents 1 km/h: so step 1 = 1 km/h, step 2 = 2 km/h, step 3 = 3 km/h... = 20: each step represents 2 km/h; step 1 = 2 km/h, step 2 = 4 km/h, last step 126 = 252 km/h. = 5: each step represents 0.5 km/h; step 1 = .5 km/h, step 2 = 1 km/h, last step 126 = 63 km/h.
#136	Km/h – Speed regulation - Control number read-out or adjustment for speed confirmation	CALIBRATION RUN or RailCom display factor	Read only  128	A numeric value can be read-out after a successful calibration run, which was used to calculate the speed. It should remain unchanged (or vary only slightly) even after multiple calibration runs. or correction factor for speed confirmation via RailCom or other method of bidirectional communication.

#### Mph instead of km/h:

Extending the calibration distance accordingly results in a mph speed regulation!

### 3.9 The ZIMO “signal controlled speed influence” (HLU)

ZIMO digital systems offer a second level of communication for transmitting data to vehicles in specific track sections. The most common application for this is the “signal controlled speed influence” for stopping trains and applying speed limits in 5 stages, with data sent to the track sections as needed in the form of HLU cut-outs prepared by MX9 track section modules or its successors. This feature only operates within ZIMO systems.

The speed limits “U”(Ultra low) and “L” (Low speed) as well as the intermediate limits of the “signal controlled speed influence” can be defined with configuration variables #51 to #55 as well as the acceleration and deceleration values (momentum) with CV #49 and #50.

Please note that the signal controlled acceleration and deceleration times in CV #49 and #50 are always **added** to the times and curves programmed to CV #3, 4, 121, 122 etc. Signal controlled accelerations and decelerations compared to cab controlled momentum can therefore only progress either at the same rate (if CV #49 and #50 is not used) or slower (if CV #49 and/or #50 contain a value of >0), but never faster.

It is of utmost importance for a flawlessly working train control system using the signal controlled speed influence that the stop and related brake section lengths are arranged properly and consistently everywhere on the layout. Please consult the MX9 instruction manual.

The deceleration (often CV #52 for "U" limit) and brake (CV #4 and #50) characteristics should be set so that all locos come to a complete stop within about 2/3 of the stop section, which in HO is typically about 15 to 20 cm before the end of a stop section. Setting the loco up to stop precisely within the last centimeter of a stop section is not recommended.

CV	Denomination	Range	Default	Description
#49	Signal controlled (HLU, ABC) acceleration	0 - 255	0	Entered value multiplied by .4 equals acceleration time in seconds from stop to full speed when: "ZIMO signal controlled speed influence" with ZIMO MX9 track section module and successors or "asymmetrical DCC signal" method (Lenz ABC) is employed
#50	Signal controlled (HLU, ABC) deceleration	0 - 255	0	Entered value multiplied by .4 equals deceleration time in seconds from full speed to complete stop when: "ZIMO signal controlled speed influence" with ZIMO MX9 track section module and successors or "asymmetrical DCC signal" method (Lenz ABC) is employed.
#51 - #55	Signal controlled (HLU) speed limits #51 #52 for "U" (Ultra low) #53 #54 for "L" (Low speed) #55	0 - 255	20 40 (U) 70 110 (L) 180	ZIMO "signal controlled speed influence" method (HLU) using MX9 or successor: Defines the internal speed steps for each of the 5 speed limits generated via HLU.
#59	Signal controlled (HLU, ABC) delay	0 - 255	5	ZIMO signal controlled speed influence (HLU) with ZIMO MX9 track section module or future module or when using the "asymmetrical DCC signal" stopping method (Lenz ABC): Time in tenth of a second until the locomotive starts to accelerate after receiving a higher signal controlled speed limit command.

### 3.10 "Asymmetrical DCC-Signal" stops (Lenz ABC)

SW-Version 36.1 and higher: also working with ABC (for example: Lenz-module BM2)

The "asymmetrical DCC signal" is an alternative method for stopping trains at a "red" signal. A simple circuit made up of 4 or 5 commercially available diodes is all that is required.

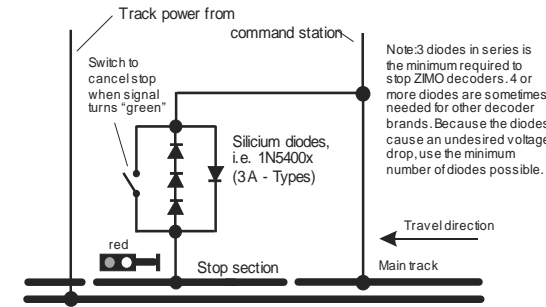

3 to 5 silicon diodes in series and **one Schottky diode in parallel in the opposite direction** is the usual arrangement. The different voltage drops across the diodes results in an asymmetry of about 1 to 2V. The direction in which the diodes are mounted determines the polarity of the asymmetry and with it the driving direction a signal stop is initiated.

The asymmetrical DCC signal stop mode needs to be activated in the decoder with CV #27. Normally Bit 0 is set, that is CV #27 = 1, which results in the same directional control as the

"Gold" decoder from Lenz.

The asymmetrical threshold (0.4V by default) can be modified with CV #134 if necessary (i.e. if the DCC signal of a given command station is already offset to begin with). At the time of this writing, the "asymmetrical DCC signal" has not been standardized and many DCC systems pay no attention to this feature.

Note: the ABC slow speed supported by Lenz decoders (i.e. by the Lenz module BM2) is supported by ZIMO decoders from SW-version 36.1.

CV	Denomination	Range	Default	Description
#27	Direction dependent stops with asymmetrical DCC signal (Lenz "ABC" method)	0, 1, 2, 3	0	Bit 0 = 1: Stops are initiated if the voltage in the right rail is higher than the left rail (in direction of travel). This setting, CV #27 = 1, is the common application for this feature (provided the decoder is wired to the rail correctly). Bit 1 = 1: Stops are initiated if the voltage in the left rail is higher than the right rail (in direction of travel). Stopping is directional if only one of the two bits is set (not both). Traveling in the opposite direction will have no effect. Use the other bit in case the train stops in the wrong direction! Bit 0 <u>and</u> Bit 1 = 1 (CV #27 = 3): Stops in both directions, regardless of rail polarity.
#49, #50	Acceleration-, deceleration time	0 - 255	0	See chapter HLU.
#53	ABC slow speed	0 - 255	70	Internal speed steps for the ABC slow speed

CV	Denomination	Range	Default	Description
#134	Asymmetrical threshold for stopping with asymmetrical DCC signal (Lenz ABC method).	1 - 14, 101 - 114, 201 - 214  = 0,1 - 1,4 V	106	Hundreds digit: Sensitivity adjustment, improves the asymmetric-recognition by changing the speed with which the asymmetry is being recognized. = 0: fast recognition (but higher risk of errors, may lead to unreliable stopping). = 1: normal recognition (@ 0.5 sec.), fairly reliable (default). = 2: slow recognition (@ 1 sec.), very reliable. Tens and ones digit: Asymmetrical threshold in tenths of a volt. The voltage difference between the two half waves of the DCC signal defines the minimum required to be recognized as asymmetrical that starts the intended effect (usually braking and stopping of a train). = 106 (Default) therefore means normal recognition at 0.6 V asymmetry. This value has proven itself to be appropriate under normal conditions; by using 4 diodes to generate the asymmetry.
#142	High-speed correction for the ABC asymmetrical stop method	0 - 255	12	A delayed recognition (see CV #134), but also unreliable electrical contact between rails and wheels, have a larger effect on a stop point at higher speeds than at lower speeds. This effect is corrected with CV #142. = 12: Default. This setting usually works fine with the default setting in CV #134.

### 3.11 DC Brake Sections, "Märklin brake mode"

These are the "classic" methods of automated speed influence or stopping at a "red" signal. The required settings for ZIMO decoders are spread over several CV's.

CV	Denomination	Range	Default	Description
#29, #124, #112	Single Bits in each of these CV's are responsible for the correct reaction to the DC and Märklin brake sections.	-	-	When using track polarity dependent <b>DC brake sections</b> set CV #29, Bit 2 = "0" and CV 124, Bit 5 = "1" For polarity independent DC braking ( <b>Märklin brake sections</b> ) set CV #29, Bit 2 = "0" and CV 124, Bit 5 = "1" and additionally CV #112, Bit 6 = "1"

### 3.12 Distance controlled stopping – Constant stopping distance

After the type "constant stopping method" has been selected with CV #140 (= 1, 2, 3, 11, 12, 13) the stopping distance will be kept as close as possible to the one defined in

CV #141,

independent of the current speed at the start of the braking sequence.

This method is especially suitable in connection with automated stops in front of a red signal with the help of the **signal controlled speed influence (ZIMO-HLU)** or the **asymmetrical DCC-signal (Lenz-ABC)**. CV #140 is set to 1 or 11 for this purpose.

Although of lesser practical value, distance controlled stopping for **manual driving** can also be activated (by programming CV #140 with appropriate values of 2, 3, 12, or 13), which is executed whenever the speed is set to 0 (by the cab, throttle, computer...).

#140	Distance controlled stopping (constant stopping distance)  Select a braking method and braking process	0 - 255	0	Activates distance controlled stopping as per CV #141 instead of time-constant braking according to CV #4. = 1: automatic stops with ZIMO HLU (signal controlled speed influence) or ABC (asymmetrical DCC signal). = 2: manual stops using the cab. = 3: automatic <u>and</u> manual stops. The start of braking is delayed in all cases above (= 1, 2 or 3) when the train travels at less than full speed, to prevent unnecessary long "creeping" (recommended). On the other hand: = 11, 12, 13 same meaning as above, but braking always starts immediately after entering the brake section.
#141	Distance controlled stopping (constant stopping distance)  Distance calculation	0 - 255	0	This CV defines the "constant stopping distance". The right value for the existing braking sections has to be determined by trial & error. Use these figures as a starting point: CV #141 = 255 is about 500m (547 yards) for a real train or 6m (20 ft) in HO. CV #141=50 about 100 m (109 yards) for a real train or 1.2m in HO (4 ft.).
#143	Distance controlled stopping, compensation using the HLU method	0 - 255	0	The HLU method is more reliable than the ABC method; no recognition delay is usually required in CV #143; this CV can remain at default value 0.

The distance controlled stopping can take place in two possible ways; see diagram below: **The first** is the **recommended method (CV #140 = 1, 2, 3)**, where a train entering at less than full speed continues at the same speed for some time before it starts braking at a "normal" deceleration rate (same rate as would be applied at full speed).

In the second method (CV #140 = 11, 12, 13), the train immediately starts braking when entering the stop section, even when entering at a lower speed, which may lead to an un-prototypical behavior. It



may however be useful to use this method if used together with decoders from other manufacturers that do not have the capability mentioned above, in order to harmonize the brake sequences. The second method may also be the preferred method if distance controlled stopping is used manually (CV #140 = 2 or 12), so that the train reacts immediately to speed changes from the throttle.

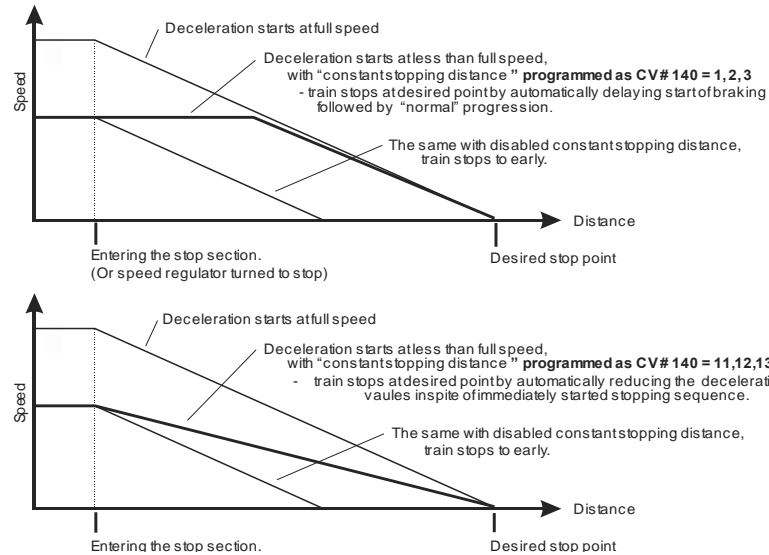

First method for constant stopping distance

Second method for constant stopping distance

☞ "Distance controlled stopping", when activated, is **exclusively** applied to decelerations leading to a **full stop**, but not to speed reductions without stopping (these are still handled by CV #4). Neither is there any influence to acceleration events.

The traveled distance is constantly being recalculated in order to get as close as possible to the desired stop point. The deceleration rate within distance controlled stopping is always applied exponentially, that is the deceleration rate is high in the top speed range followed by gentle braking until the train comes to a full stop; which in this case is *not* governed by CV #122! The application of CV #121 for exponential acceleration however remains unchanged.

### 3.13 Shunting, Half-Speed and MAN Functions:

On the one hand, defining the different Configuration Variables (#3, 4, 121, 122 and 123) offers prototypical acceleration and deceleration behavior, but is on the other hand often obstructive for quick and easy shunting.

This is why the momentum can temporarily be reduced or eliminated altogether with a dedicated function key. Also, during shunting maneuvers it is sometimes helpful to have the speed range of the throttle cut in half.

For historical reasons, the assignments for these "shunting-key functions" are summarized in CV #124, which is associated with restrictions and also relatively confusing.

**From today's perspective**, CV's #155, #156 and #157 are the **preferred** CV's for these settings, where function keys can be selected in a systematic and unlimited manner for each of the shunting and MAN functions. CV #124 (Bits 0 & 1) is still relevant though for the type of momentum deactivation.

#124	Shunting key functions:  Low gear (half speed) and Momentum reduction or deactivation  NOTE: Extended shunting key selection in CV's #155, 156  Bit 5 DC stopping Bit 7 Changing SUSI pins to logic level outputs	Bits 0 - 4, 6	0	Select a function key for LOW GEAR ACTIVATION: Bit 4 = 1 (and Bit 3 = 0): F3 as half-speed key Bit 3 = 1 (and Bit 4 = 0): F7 as half-speed key  Select a function key for MOMENTUM DEACTIVATION: Bit 2 = 0 (and Bit 6 = 0): "MN" key for deactivation, Bit 2 = 1 (and Bit 6 = 0): F4 key for deactivation Bit 6 = 1 (Bit 2 is irrelevant): F3 for deactivation.  Effect of above key (MN, F3 or F4) on MOMENTUM: Bit 1, 0 = 00: no effect on momentum = 01: removes momentum of CV #121 + #122 = 10: CV #3 + #4 reduced to ¼. = 11: removes all momentum above.  EXAMPLES: F3 for half speed-key: CV #124 = 16. F3 for half speed-key and F4 to remove momentum completely: Bits 0, 1, 2 & 4 = 1; that is CV #124 = 23. F3 for half-speed key <u>and</u> removing momentum: Bits 0, 1, 4 & 6 = 1; that is CV #124 = 83.  Bit 5 = 1: "DC stopping" Bit 7 = 0: SUSI-interface active = 1: FU-outputs active instead of SUSI.
#155	Selecting a function key as half-speed key	0 - 19	0	Expanding on the settings of CV #124; if another key is required than F3 or F7: CV #155: Defines a function key for half-speed activation (= top speed cut in half). If a key is assigned with CV #155, a possible assignment through CV #124 is disabled. CV #155 = 0 doesn't mean that the F0 key is assigned but rather that the setting in CV #124 is active.
#156	Selecting a function key for deactivating momentum	0 - 19	0	This CV deactivates the configuration for F-keys in CV #124 (Bits 2&6) in case they are not satisfactory. The effects (Bits 0&1) of the momentum don NOT change. The assignment of a key for the deactivation of the momentum is deactivated, if CV 156>0 (i.e.: a key is defined here). Additionally you can suppress the change of the lights when changing direction with Bit 7=1. After defining a key with this CV, the momentum deactivation or reduction still needs to be defined in CV #124: CV #124, Bit 1, 0: = 00: no effect on momentum

				= 01: removes momentum of CV #121 + #122 = 10: CV #3 + #4 reduced to ¼. = 11: removes all momentum.  In order to deactivate all momentum, CV #124 is typically set to a value of 3 (the total value may be different if other Bits in CV #124 are also set).
#157	Selecting a function key for the MAN function  Only for non-ZIMO cabs that don't have the dedicated MN key.	0 - 19	0	The MAN function (or MAN key on ZIMO cabs) was originally designed for ZIMO applications only, in order to cancel stop and speed limit commands applied by the signal controlled speed influence system (HLU).  This function was expanded in later software versions to include "asymmetrical DCC signal stops" (Lenz ABC).  If ZIMO decoders are used with non-ZIMO systems that don't have this key, a function key can now be assigned with CV #157 to cancel a signal controlled speed limit or stop command.

### 3.14 The NMRA-DCC function mapping

ZIMO small-scale decoders have between 4 and 12 function outputs (FO). Things connected to these outputs (lights, smoke generator etc.) are switched ON and OFF with the function keys of the cab. Which function key controls which function output can be defined with the NMRA's function mapping

CV's #33 to #46.

Unfortunately, this function mapping also has its limitations (only one 8-Bit register is available for each function, which leaves only 8 outputs to select from) and only the headlight function is intended to change with direction.

Function key on the cab	CV	Number key on ZIMO cabs	Function outputs					Function outputs								
			FA12	FA11	FA10	FA9	FA8	FA7	FA6	FA5	FA4	FA3	FA2	FA1	Rear light	Front light
F0	#33	1 (L) fw							7	6	5	4	3	2	1	0
F0	#34	1 (L) re							7	6	5	4	3	2	1	0
F1	#35	2							7	6	5	4	3	2	1	0
F2	#36	3							7	6	5	4	3	2	1	0
F3	#37	4				7	6	5	4	3	2	1	0			
F4	#38	5				7	6	5	4	3	●	1	0			
F5	#39	6				7	6	5	4	3	●	2	1	0		
F6	#40	7				7	6	5	4	●	3	2	1	0		
F7	#41	8	7	6	5	4	3	2	●	1	0					

F8	#42	9	7	6	5	4	3	●	2	1	0					
F9	#43	0	7	6	5	4	●	3	2	1	0					
F10	#44	↑ 1	7	6	5	●	4	3	2	1	0					
F11	#45	↑ 2	7	6	●	5	4	3	2	1	0					
F12	#46	↑ 3	7	●	6	5	4	3	2	1	0					

The black dots in the table above indicate the default settings at the time of delivery, where each function key corresponds to the same numbered function output. Therefore, the following values were written to these CV's by default:

- CV #33 = 1
- CV #34 = 2
- CV #35 = 4
- CV #36 = 8
- CV #37 = 2
- CV #38 = 4
- CV #39 = 8
- CV #40 = 16
- CV # 41 = 4
- and so on..

EXAMPLE of a modification: The F2 key (ZIMO #3 key) should switch in addition to output FO2 also output FO4. Moreover, F3 and F4 should NOT switch FO3 and FO4 but rather FO7 and FO8 (couplers, for example). New values are to be entered into the relevant configuration variables as follows:

- CV #36=40
- CV #37 = 32
- CV #38 = 64

F2	3	#36							7	6	5	4	3	2	1	0
F3	4	#37					7	6	5	4	3	2	1	0		
F4	5	#38					7	6	●	5	4	3	2	1	0	

### 3.15 The extended ZIMO function mapping (not for MX621)

Since the original NMRA function mapping does not allow for some desirable configurations some extensions are offered by ZIMO decoders, which are described on the following pages. Most of these options are related to the ZIMO special

CV #61.

Note: Some of the CV #61 variations (1, 2, 3...) have been replaced over the years by other more practical applications.

Programming

**CV #61 = 97** offers an **Alternative "function mapping" without "left shift":**

CV #61 = 97 abolishes the left shift of higher CV's (#37 and up, according to the original NMRA function mapping), which allows higher function keys to be mapped with lower function outputs (i.e. Func-

tion output 1 (FO1) cannot be mapped with function key F4 using the NMRA function mapping, but is possible with the ZIMO extended mapping).

			FO6	FO5	FO4	FO3	FO2	FO1	Headlight rear	Headlight front
F0	1 (L) for.	#33	7	6	5	4	3	2	1	0 ●
F0	1 (L) rev.	#34	7	6	5	4	3	2	1 ●	0
F1	2	#35	7	6	5	4	3	2 ●	1	0
F2	3	#36	7	6	5	4	3 ●	2	1	0
F3	4	#37	7	6	5	4 ●	3	2	1	0
F4	5	#38	7	6	5 ●	4	3	2	1	0
F5	6	#39	7	6 ●	5	4	3	2	1	0
F6	7	#40	7 ●	6	5	4	3	2	1	0
F7	8	#41	7	6	5	4	3	2	1	0
F8	9	#42	7	6	5	4	3	2	1	0

**NOTE:** The earlier options CV #61 = 1, 2, 11...15 as well as CV #61 = 98 were discontinued with SW-Version 34 and replaced with the "Swiss Mapping" (see next chapter).

*Tip: Directions dependent taillights with the help of special effect CV's:*

With the NMRA function mapping it is only possible to have function F0 directional and was intended for the headlights, so they automatically switch between "front" and "rear" when changing direction. All other functions are controlled direction-independent.

The special effect CV's #125 ... 132, #159 and #160 (see chapter "Special function output effects"), each assigned to a function output (up to FO8), make it possible to have more direction dependent functions. To utilize the directional capabilities of these CV's use only the directional Bits (0 or 1) without the actual effect Bits.

**Example 1:** A couple of **red taillights** are connected to function outputs FO1 and FO2 (front and rear of engine). Both are to be actuated with F1 but should also change with direction. This requires the following CV settings:

CV #35 = 12 (Bit 2 for FO1 and Bit 3 for FO2), as well as effect CVs: CV #127 = 1 (for FO1) and CV #128 = 2 (for FO2).

Therefore FO1 is only activated in forward direction and FO2 only in reverse, and only if the function is turned ON with the function key F1.

**Example 2:** Contrary to example 1 where the red taillights were switched independent from the white headlights, in this example the headlights and taillights are switched ON/OFF together at the proper end of the locomotive with F0 or F1 (depending on which end the loco is coupled to the train).

This can be done as follows:

Connect: White front headlights connected to function output "front headlights"  
 Red front taillights to function output FO2  
 White rear headlights to function output FO1  
 Red rear taillights to function output "rear headlights" (!).

CV #33 = 1 and CV #34 = 8 front white headlights on F0forw and front red taillights on F0rev!  
 CV #35 = 6 (both white headlights as well as red taillights in the rear on F1!)

CV #126 = 1 / CV #127 = 2 (Direction dependence for rear white and red lights by means of "Special Effects" CV).

### 3.16 "Unilateral Light Suppression"

This new feature (since SW version 30.7, supplemented with 33.18), asked for by many users, makes it possible to switch off all lighting on one side of a locomotive with the push of one function key (usually on the "train side", i.e. where cars are coupled to the locomotive).

CV	Denomination	Range	Default	Description
#107	Light suppression (i.e. front headlights AND additionally defined function output) at cab side 1 (front)	0 - 255	0	The value of this CV is calculated as follows: The number of a function output (FO1...FO6) x 32 + number of a function key (F1, F2...F28) = Value of CV #107 Function Key: The key (F1...F28) which should turn off ALL lights on the cab side 1 (front side) AND Function Output: i.e. taillights on the same side.
#108	Cab side 2 (rear)	0 - 255	0	Same as CV #107 but for other locomotive side.
#109	Add. Fu-output at cab 1	1...6	0	Function output is turned off together with CV #107.
#110	Add. Fu-output at cab 1	1...6	0	Function output is turned off together with CV #108.

### 3.17 The "Swiss Mapping"

(SW version 32 and higher, dimming possibilities added with SW version 34)

The "Swiss mapping" is a function mapping that allows the **loco lighting** to be used as is required by Swiss locomotives, which is of course also useful for locos of other countries.

The purpose of the "Swiss mapping" is to switch the various states of the locomotive lighting with different function keys, i.e. for situations like driving a single locomotive, cars coupled on driver's cab 1, or at the driver's cab 2, push-pull, shunting, etc.

Using this relatively complex method is of course only worthwhile if the vehicle is equipped with many independently connected lights (or LED's) and the decoder offers as many function outputs, at least 6. ZIMO decoders offer indeed between 6 and 10 function outputs (with the exception of a few miniature decoders), large-scale decoders even more.

The desired lighting states are defined by **a total of 17 CV groups, each group containing 6 CV's**. A total of 10 such groups can be used (= 78 CV's; CV #430 - #507). The principle is simple in itself, in that the first CV of each group contains the number (1 to 28) for a function key F1 .. F28, and the other CVs define which function outputs are to be switched on when pressing this key, each dependent on the direction of travel.

ATTENTION: only sound decoders have 17 CV groups for the swiss mapping.

Non-sound decoders: MX618, MX633 and MX634 have 13 CV groups (CV430-CV507) and the other decoder types have 8 CV groups (CV430 - CV477).

CV	Denomination	Range	Default	Description
#430	Swiss Mapping Group 1 "F-Key"	0 - 28, 29 (for F0), 129 - 157	0	The key defined here shall turn on the function outputs listed under A1 (forward or reverse) and A2 (forward or reverse). 1 - 28 for function keys F1 - F28, F29 is for F0. Bit 7 = 1: Inverts the F-key function.
#431	Swiss Mapping Group 1 "M-Key" or Special high-beam setting (from SW version 34)	Bit 0 - 6: 0 - 28, 29 (for F0) and Bit 7 or 255	0	The "normal function mapping" for the "M-key" defined here will be deactivated (that is the relevant outputs, such as the headlights for example) when the "F-key" is switched on. Bit 7 = 1: additionally, the outputs listed under A1 and A2 should only switch ON if the F and M key is ON. Bit 6 = 1: The M-key outputs shall not be turned OFF if the F-key is ON and driving forward. Bit = 5: The M-key outputs shall not be turned OFF if the F-key is ON and driving backwards. = 157: is an often used value for CV #431, because F0 (= 29) is usually selected as the "M-key" with Bit 7 = 1. F0 then acts as a general ON/OFF key. = 255 (Special <b>high-beam</b> setting!): the Fu-Outputs defined in the following four CVs are switched to full intensity, provided that they are controlled via the "normal function mapping", and dimmed with CV # 60; this function is used, for example, to switch the headlights of a Swiss locomotive to high-beam, without switching the white taillight to high-beam. Depending on CV #399 setting (see also below): High beam is only switched on if the speed is higher than the value given in this CV (in 255 speed step mode).
#432	Swiss Mapping Group 1 "A1" forward	Bits 0...3: 1 - 12 14 (FOOf) 15 (FOOr) Bits 5...7: 0 - 7	0	Bits 0...3: Function output to be switched ON in forward direction provided that <u>both</u> the "F" and "M" keys are ON (if Bit #7 for the "M" key CV is = 1, otherwise "F" key ON is sufficient) . Bits 7, 6, 5 (7 possible values or zero): Number of the applicable dimming CV. For example: Bit 5 = 1 means dimming according to CV #508 etc.
#433	Swiss Mapping Group 1 "A2" forward	Bits 0...3: 1 - 12 14 (FOOf) 15 (FOOr) Bits 5...7: 0 - 7	0	Bits 0...3: Additional function output to be switched ON in forward direction provided that <u>both</u> the "F" and "M" keys are ON (if Bit #7 for the "M" key CV is = 1, otherwise "F" key ON is sufficient) . Bits 7, 6, 5 (7 possible values or zero): Number of the applicable dimming CV. For example: Bit 5 = 1 means dimming according to CV #508 etc.

#434	Swiss Mapping Group 1 "A1" reverse	Bits 0...3: 1 - 12 14 (FOOf) 15 (FOOr) Bits 5...7: 0 - 7	0	Bits 0...3: Function output to be switched ON in forward direction provided that <u>both</u> the "F" and "M" keys are ON (if Bit #7 for the "M" key CV is = 1, otherwise "F" key ON is sufficient) . Bits 7, 6, 5 (7 possible values or zero): Number of the applicable dimming CV. For example: Bit 5 = 1 means dimming according to CV #508 etc.
#435	Swiss Mapping Group 1 "A2" reverse	Bits 0...3: 1 - 12 14 (FOOf) 15 (FOOr) Bits 5...7: 0 - 7	0	Bits 0...3: Additional function output to be switched ON in forward direction provided that <u>both</u> the "F" and "M" keys are ON (if Bit #7 for the "M" key CV is = 1, otherwise "F" key ON is sufficient) . Bits 7, 6, 5 (7 possible values or zero): Number of the applicable dimming CV. For example: Bit 5 = 1 means dimming according to CV #508 etc.
#436 - 441	... Group 2	...	0	All 6 CV's of Group 2 are defined the same way is the 6 CV's in group 1.
#442 - 447	... Group 3	...	0	All 6 CV's of the following groups are defined the same way is the 6 CV's in group 1.
#448 - 453	... Group 4	...	0	...
#454 - 459	... Group 5	...	0	...
#460 - 465	... Group 6	...	0	...
#466 - 471	... Group 7	...	0	...
#472 - 477	... Group 8	...	0	...
#478 - 483	... Group 9	...	0	...
#484 - 489	... Group 10	...	0	...
#490 - 495	... Group 11	...	0	... (Groups 11, 12, 13 with SW version 34 or higher)
#496 - 501	... Group 12	...	0	...
#502 - 507	... Group 13	...	0	...
#800 - #805	... Group 14	...	0	... (Groups 14, 15, 16, and 17 with SW version 35.27 or higher)
#806 - #811	... Group 15	...	0	...

#812 - #817	... Group 16	...	0	...
#818 - #823	... Group 17	...	0	...
#508 #509 #510 #511 #512	Dimming values for "Swiss Mapping"	(0- 31)*8 (only Bits 7...3 are used)	0	Each group CV (i.e. #432, 433, 434, 435) can be linked with one of these five dimming CV's. The value to enter is the dimming value (0 – 31) times the function output number (i.e. dimming value = 16 for function output 6: 16 x 6 = 96 is the value to enter). This will dim the relevant function outputs accordingly. Usable only with function outputs FO0 to FO8.  Bit 0 = 1: suppresses the lighting effect (SW-Version 36.1 and higher) Bit 1 = 1: flashing (SW-Version 37.0 and higher) Bit 2 = 1: inverted flashing (SW-Version 37.0 and higher)
#399	Speed dependent headlights (Rule 17)	0 - 255	0	In conjunction with the "Swiss Mapping" special "high-beam" setting, see CV #431 = 255; applies to each of the 13 CV groups (CV #437, 443.): Switches to high-beam only when the speed exceeds the value in this CV; based on the decoder internal 255 speed steps. EXAMPLE: = 0: High-beam at any speed (incl. stand-still), controlled only by the F-key (i.e. as per CV #430). =1: High-beam only while driving (not at stand-still), provided the defined F-key is ON. = 128: Switches to high-beam when reaching medium speed.

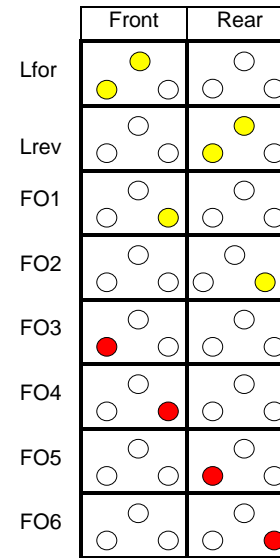

The application of the "Swiss Mapping" is shown here with the **example** of an SBB Re422 engine.

◀ The function outputs together with the connected lights or groups of lights are shown here as they exist in a typical SBB (Swiss) electric locomotive.

The task of the "Swiss Mapping", with the help of the function keys

F0 (General ON/OFF), and

F15, F16, F17, F18, F19 and F20,

is to correctly switch the lights in all possible operating conditions (of course in both directions).

This results in the status table shown on the right, for which the following configurations are required in the "Swiss Mapping" (below): ▶

#33 = 133	#34 = 42				
#430 = 15	#431 = 157	#432 = 14	#433 = 1	#434 = 15	#435 = 1
#436 = 15	#437 = 157	#438 = 2	#439 = 0	#440 = 2	#441 = 0
#442 = 16	#443 = 157	#444 = 14	#445 = 1	#446 = 2	#447 = 4
#448 = 17	#449 = 157	#450 = 5	#451 = 6	#452 = 15	#453 = 2
#454 = 18	#455 = 157	#456 = 6	#457 = 0	#458 = 4	#459 = 0
#460 = 19	#461 = 157	#462 = 2	#463 = 0	#464 = 1	#465 = 0
#466 = 20	#467 = 157	#468 = 0	#469 = 0	#470 = 0	#471 = 0

**Explanation:**

The normal NMRA function mapping in CV #33 and CV #34 (front and rear headlight) determines the lighting in case when F0 is ON and function keys F15 – F20 are OFF:  
CV #33 = 133 (= Lfor, FO1, FO6) and CV #34 = 42 (= Lrev, FO2, FO4).

The following CV groups (1. Group: CV #430 – 435, 2. Group: CV #436 – 441 etc.), each group shown on one line, contain in the first CV the number of the "F-key" F15, F16, F17, F18, F19, F20, followed by the CV's for the "M-key" and function outputs to be switched.

Note that there are two groups for F15 (CV #430... and #436...) because F15 should switch 3 function outputs simultaneously, but only 2 can be entered per group (A1, A2 for each direction); one group is sufficient for all other "F-Keys".

All "M-Keys" (the second CV in each group) are all set to "157"; this means that "F0" and the condition of Bit 7 must be met, which means that the selected outputs are only activated if the F and M keys are ON.

The third to sixth CV's in each group contain the numbers of the function outputs to be actuated (where the headlights are coded with "14" and "15", for all other outputs just use the digit in FO1, FO2...).

Functions, Keys	Outputs		Front	Rear
F0, forward (Cab 1 forward)	Lfor FO1 FO6	Locomotive only		
F0, reverse (Cab 2 forward)	Lrev FO2 FO4	Locomotive only		
F0 + F15, forward (Cab 1 forward)	Lfor FO1 FO2	Train, cars coupled at cab 2, standard train without pilot car.		
F0 + F15, reverse (Cab 2 forward)	Lrev FO1 FO2	Train, cars coupled at cab 1, standard train without pilot car.		
F0 + F16, forward (Cab 1 forward)	Lvor FO1	Train, cars coupled at cab 2, standard train with pilot car or first engine in a double header.		
F0 + F16, reverse (Cab 2 forward)	FO3 FO4	Loco pushing, cars coupled to cab 2, with pilot car or first engine in a double header. (prototypical since 2000)		
F0 + F17, reverse (Cab 2 forward)	Lrev FO2	Loco pulling, cars coupled to cab 1, train with pilot car or first engine in a double header.		
F0 + F17, forward (Cab 1 forward)	FO5 FO6	Loco pushing, cars coupled to cab 1, with pilot car (prototypical since 2000).		
F0 + F18, forward, (Cab 1 forward)	FO6	Loco pushing, cars coupled to cab 1, with pilot car or last engine in a double header. (prototypical up to 2000)		
F0 + F18, reverse (Cab 2 forward)	FO4	Loco pushing, cars coupled to cab 2, with pilot car or last engine in a double header. (prototypical up to 2000)		
F0 + F19, forward (Cab 1 forward)	FO2	Loco pulling as last engine in consist, cars coupled to cab 2.		
F0 + F19, reverse (Cab 2 forward)	FO1	Loco pulling as last engine in consist, cars coupled to cab 1.		
F0 + F20, forward/reverse	---	Engine(s) inside a consist		

### 3.18 The ZIMO "Input Mapping" (ONLY for sound decoders)

SW versions 34 and up, also for function outputs via SUS!!

The NMRA function mapping limitations (only one of 8 functions per one of the 12 function keys) can be overcome with the ZIMO "input mapping". In addition, the function keys (= **external functions**) can quickly be adapted to the wishes of the operator and that for both, function outputs and sound functions, without the need of changing the **internally mapped functions** and especially without changes to the sound projects:

CV's #400 ... #428

CV	Denomination	Range	Default	Description
#400	Input mapping for internal F0 that is, which function key switches the internal (decoder) function F0.	0, 1 - 28, 29 30 - 187. 254, 255	0	= 0: Key F0 (that is, F0 received from the DCC-packet) is sent to the internal (decoder) F0 (1:1). = 1: Key F1 is sent to the internal F0. ..... = 28: Key F28 is sent to the internal F0. = 29: Key F0 is sent to the internal F0. = 30: Key F1 to F0, only in forward direction. ..... = 57: Key F28 to F0, only in forward direction. = 58: Key F0 to F0, only in forward direction. = 59: Key F1 to F0, only in reverse direction. ..... = 86: Key F28 to F0, only in reverse direction. = 87: Key F0 to F0, only in reverse direction. = 101: Key F1-inverted to internal F0 ..... = 187: Key F0- inverted to internal F0, in reverse dir. = 254: Directions Bit to internal F0, in forward dir. = 255: Directions Bit to internal F0, in reverse dir.
#401 - #428	Input mapping for internal F1 ... F28	0, 1 - 28, 29, 30 - 255	0	Same as input mapping above for other functions: CV #401 = 0: Key F1 to internal F1 = 1: Key F1 to internal F1 = 2: Key F2 to internal F1 and so on.

### 3.19 Dimming, Low beam and Direction Bits

Some things connected to function outputs may sometimes require less than full track voltage, as is the case for example with 18V bulbs when having 24V on the track (quite common on large scale model railroads). Other times you simply want to reduce the brightness of the headlights.

The best solution in such cases is to connect the positive side of such devices to the low voltage supply of the decoder (see chapter "Installation and wiring"). These outputs are fully stabilized so the voltage does not fluctuate with changes in track voltage.

Alternatively or in addition to this, the PWM voltage reduction is also available with

CV #60,

which defines the PWM duty cycle (Pulse Width Modulation; the dimming is also effective when connected to the positive terminal of a low-voltage function output). Of course, this kind of voltage reduction is interesting because it is easy to change at any time by changing the value in CV #60.

☞ NOTE: Bulbs with voltage ratings as low as 12V can be dimmed with this PWM dimming function without damage even if track voltages are considerably higher; but **not** bulbs rated below that such as 5V or 1.2V bulbs. These must be connected to one of the decoder's low voltage supply pins instead of a "normal" positive pin (see chapter "Installation and Wiring").

☞ LED's, on the other hand, always require a series resistor; if however, a resistor is selected that lowers the voltage to 5 V, the PWM dimming can also be used even at a track voltage of 25V (in this case the setting would be CV #60 = 50, so a reduction to one fifth).

CV #60 affects all function outputs but specific outputs can be excluded from the dimming function, using the dim mask CV's (see table).

CV	Denomination	Range	Default	Description
#60	Reduced function output voltage (Dimming).  Affects all function outputs.	0 - 255	0	Reduction of function output voltage with PWM (pulse-width modulation). Useful for headlight dimming for example. <u>Example values:</u> CV #60 = 0 or 255: full voltage CV #60 = 170: 2/3 of full voltage. CV #60 = 204: 80% of full voltage.
#114	Dim Mask 1 = Excludes certain function outputs from dimming per CV #60.  For higher function outputs go to CV #152.	Bits 0 - 7	0	Enter function outputs that are <b>not</b> to be <b>dimmed</b> by CV #60. These outputs will receive the full voltage from the pin they are connected to that is, either full track voltage or low voltage from a low-voltage pin. Bit 0 - front headlight, Bit 1 - rear headlight, Bit 2 - function output FO1, Bit 3 - FO2, Bit 4 - function output FO3, Bit 5 - FO4 Bit 6 - function output FO5, Bit 7 - FO6 Respective Bit = 0: Output will be dimmed to the value defined in CV #60. Respective Bit = 1: Output will not be dimmed. <u>EXAMPLE:</u> CV #114 = 60: FO1, FO2, FO3 and FO4 will not be dimmed; front and rear headlights will be dimmed according to CV #60.
#152	Dim Mask 2 (Excludes specific function outputs from dimming as per CV #60)  Continuation of CV #114 and FO3, FO4 as direction bit mapping	Bits 0 - 5  and Bit 6, Bit 7	0  0	... Continuation of CV #114. Bit 0 - function output FO7, Bit 1 - function output FO8, Bit 2 - function output FO9, Bit 3 - function output FO10, Bit 4 - function output FO11, Bit 5 - function output FO12. Bit 6 = 0: "normal" = 1: "Direction bit" to FO3 and FO4 that is, FO3 is switched on when driving in reverse, FO4 when driving forward (normal mapping for FO3 and FO4 is cancelled). Bit 7 = 1: "Direction bit" for FO9 in Fwd direction.

### Low/high beam mask

One of the function keys F6 (CV #119) or F7 (CV #120) can be defined as a low beam key. Selected function outputs can be dimmed as required with the function turned ON or OFF (inverted action with Bit 7).

CV	Denomination	Range	Default	Description
#119	Low beam mask for F6  Output assignment for (example) low/high beam headlights  ATTENTION: Certain settings in CV #154 (Special output configurations for OEM projects) change the meaning of CV's #119 and #120 and therefore will no longer be a low-beam mask.	Bits 0 - 7	0	Selected outputs will dim, according to the dim value in CV #60, when the F6 key is actuated.  Typical application: Low/high beam Bit 0 - front headlight, Bit 1 - rear headlight, Bit 2 - function output FO1, Bit 3 - function output FO2, Bit 4 - function output FO3, Bit 5 - function output FO4.  Respective Bit = 0: Output will not be dimmed, Respective Bit = 1: Output will be dimmed with F6 to value defined in CV #60.  Bit 7 = 0: normal action of F6. = 1: inverted action of F6. <u>EXAMPLE:</u> CV #119 = 131: Function key F6 toggles headlights between low and high beam.
#120	Low beam mask for F7	Bits 0 - 7		Same as CV #119 but with F7 as low beam key.

### A "second dim value" with the help of the uncoupler CV

If more function outputs need to be dimmed than CV #60 allows or if some function outputs require a different voltage and the uncoupler function is not needed on the same vehicle then

#### CV #115

can be used for an alternative dimming configuration. The respective function outputs must be defined as "uncoupler output" in the corresponding

CV's #127...#132, #159 and #160  
(see "Special effects for function outputs).

CV	Denomination	Range	Default	Description
#115	Uncoupler control or Second dim value	0 - 9	0	Only active if "uncoupler" function is selected (value 48) in CV #125 ...132, 159 or 160: Tens digit = 0: when used for dimming applications Ones digit (0 to 9): PWM – voltage reduction (0 to 90%)

#127	Effects on			Value = 48 for dimming application
-	FO1, FO2,		0	#127 → FO1 #128 → FO2
#132	FO3, FO4, FO5, FO6		0	#129 → FO3 #130 → FO4
#159	on FO7			#131 → FO5 #132 → FO6
#160	on FO8			#159 → FO7 #160 → FO8

NOTE: Dimming can also be achieved with CV's #137, 138 & 139 (see chapter 3.23)

### 3.20 Flasher Effect

Flashing is actually a lighting effect just like all the others that are summarized in the CV's starting with #125; for historical reasons though they are listed with their own CV's #117 and #118.

CV	Denomination	Range	Default	Description
#117	Flasher functions Outputs are assigned in CV #118.	0 - 99	0	Duty cycle for flasher function: Tens digit = OFF time / Ones digit = ON time (0 = 100msec, 1 = 200msec.....9 = 1 sec) <u>Example:</u> CV #117 = 55: Flashes evenly at 1 a second interval.
#118	Flashing mask - Defines which outputs operate as flashers. Rhythm is defined in CV #117	Bits 0 - 7	0	Selected function outputs will flash when turned ON. Bit 0 - front headlights Bit 1 - rear headlights Bit 2 - function output FO1, Bit 3 - ...FO2 Bit 4 - ...FO3, Bit 5 - function output FO4. Respective Bit = 0: No flasher Respective Bit = 1: Output flashes when turned ON. Bit 6 = 1: FO2 flashes inverse! Bit 7 = 1: FO4 flashes inverse! (for alternate flashing, i.e. wig-wag) <u>EXAMPLE:</u> CV #118 = 12: FO1 and FO2 are defined as flashers. CV #118 = 168: Alternate flashing of FO2 and FO4, if both are switched on.

### 3.21 F1-Pulse Chains (Only for old LGB products)

CV	Denomination	Range	Default	Description
#112	Special ZIMO configuration Bits	0 - 255	4 = 00000100 ... (Bits 4 and 7 = 0)	Bit 3 = 0: 12-Function mode = 1: 8-Function mode Bit 4 = 0: Pulse chain recognition OFF = 1: Pulse chain recognition ON (use with old LGB systems) ... Bit 7 = 0: No pulse chain generation = 1: Generates pulse chain commands for LGB sound modules.

### 3.22 Special Effects for Function Outputs

(US and other lighting effects, smoke generators, uncouplers etc.)

Special effects can be assigned to a total of 10 function outputs with

CV's #125, #126, #127 ... #132, #159, #160  
for F0fr., F0rear. FO1 ..... FO6 , FO7 , FO8

The values for these special effect CV's contain the

actual 6-Bit special effects code and the 2-Bit directions code

	Bits 1,0 = 00: bidirectional (active in both directions)	
	= 01: active in forward direction only (+ 1)	
	= 10: active in reverse direction only (+ 2)	
Bits 7 ... 2 =	000000xx No effect, except for	direction = (0), 1, 2 (bidirectional, forward, reverse)
	= 000001xx Mars light	+ direction = 4, 5, 6 (bidirectional, forward, reverse)
	= 000010xx Random flicker	+ direction = 8, 9, 10 (ditto, ditto, ditto)
	= 000011xx Flashing headlight	+ direction = 12, 13, 14 ...
	= 000100xx Single pulse strobe	+ direction = 16, 17, 18
	= 000101xx Double pulse strobe	+ direction = 20, 21, 22
	= 000110xx Rotary beacon	+ direction = 24, 25, 26
	= 000111xx Gyalrite	+ direction = 28, 29, 30
	= 001000xx Ditch light type 1, right	+ direction = 32, 33, 34
	= 001001xx Ditch light type 1, left	+ direction = 36, 37, 38
	= 001010xx Ditch light type 2, right	+ direction = 40, 41, 42
	= 001011xx Ditch light type 2, left.	+ direction = 44, 45, 46
	= 001100xx Uncoupler as defined in CV #115	= 48, 49, 50
	automatic disengagement in CV #116	
	= 001101xx "Soft start" = slow dimming up of function output	= 52, 53, 54
	= 001110xx Automatic stoplights for trams,	
	stoplight-off delay, see CV #63.	= 56, 57, 58
	= 001111xx Function output turns itself off at speed >0	= 60, 61, 62
	(i.e. turns off cab light when driving).	
NOT for MX621	= 010000xx Function output turns itself off after 5 minutes	= 64, 65, 66
	(i.e. to protect smoke generators form overheating).	
-.-	= 010001xx As above, but after 10 minutes	= 68, 69, 70
-.-	= 010010xx Speed or load dependent <b>smoke generation</b>	= 72, 73, 75
	for <b>steam engines</b> as per CV's #137 - #139 (i.e. pre-heating at stand still, heavy smoke at high speed or high load). Smoke turns off as per CV #353; function key has to be pressed to reactivate smoke.	
-.-	= 010100xx Driving state-dependent <b>smoke generation</b> for <b>diesel engines</b>	= 80, 81, 82
	as per CV's #137 - #139 (i.e. pre-heating at stand still, heavy smoke during motor start-up sound and acceleration). Synchronized control of fan connected to the fan output. Smoke turns off as per CV #353; function key must be pressed to reactivate smoke.	
-.-	= 100010xx Slow fade in/out of a function output; useful for various	= 88, 89, 90
	lighting effects or motorized equipment (i.e. fan, snow blower). Dimming time is set with CV's #190 and #19	(SW version 33.10 and higher)
-.-	= 010111xx effect of fluorescent lamp (SW-Version 36.7 and higher)	= 92, 93, 94
-.-	= 011000xx sparks with hevly braking (SW-Version 37.0 and higher)	= 96, 97, 98



The effect-CV's are also suitable for **direction dependent function outputs without using a special effect** (with effect code 000000).

**EXAMPLE:**  
CV #127 = 1, CV #128 = 2, CV #35 = 12 (FO1, FO2 operate directional, ON/OFF with F1 key).

CV	Denomination	Range	Default	Description
#125 <sup>1</sup>	Special effects According to list above for function output F0 (front headlight)  Effects can be further adjusted and modified with CV's #62 - 64 and CV #115, #116 (for uncoupler).		0	Bits 1, 0 = 00: bidirectional (active in both directions) = 01: only active in forward direction = 10: only active in reverse direction  ATTENTION in case of CV #125 and #126: change CV's #33, 34.... if direction is wrong! Bits 7, 6, 5, 4, 3, 2 = Effect-Code <b>EXAMPLES</b> You want: Program CV #125 to: Mars light forward only - 00000101 = 5 Gyalrite independent of direction - 00011100 = 28 Ditch type 1 left, only forward - 00100101 = 37 Uncoupler - 00110000 = 48 Soft start of output - 00110100 = 52 Automatic stop light - 00111000 = 56 Automatic cab light OFF - 00111100 = 60 Speed/load depen. smoke - 01001000 = 72 Speed/load depen. diesel smoke - 01010000 = 80
#126	Special effects for rear headlight (default F0 reverse)		0	As in CV #125, only for rear headlights #125 → Front headlight #126 → Rear headlight
#127 - #132	Special effects for FO1, FO2, FO3, FO4, FO5, FO6  FO3 and up NOT for MX621		0	See CV #125 for details #127 → FO1 #128 → FO2 #129 → FO3 #130 → FO4 #131 → FO5 #132 → FO6
#159, #160	Special effects for FO7, FO8		0	See CV #125 for details #159 → FO7 #160 → FO8 ATTENTION: "Coupler" and "Smoke" effects could be used with FO0 - FO6 have now moved to FO7 - FO8 with SW version 34 or higher.
#62	Effects modifications	0 - 9	0	Change of minimum dimming value
#63	Light effects modifications or Stop light OFF delay	0 - 99 0 - 255	51	Tens digit: sets cycle time (0 - 9, default 5), or start-up time during "soft start" with 001101 (0 - 0,9s) Ones digit: extends OFF time For stop light OFF delay (001110xx in CV #125, 126 or 127): Time in tenths of a second the stop lights re-

<sup>1</sup> Note to ditch lights: Ditch lights are only active when headlights and function F2 (#3 on Zimo cab) are on, which is prototypical for North American railroads. The ditch lights will only be working if the applicable bits in CV #33 and 34 are on (the definition in CV #125 - 128 in itself is not enough but a necessary addition). Example: If ditch lights are defined for FO1 and FO2, the bits 2 and 3 in CV #33 and 34 have to be set accordingly (i.e. CV #33 = 13 (00001101), CV #34 = 14 (00001110)).

				main ON after the tram comes to a full stop (range: 0 - 25 sec.).
#64	Effects modifications	0 - 255	0	<a href="#">Bit 7 - 4</a> : define a ditch light-key (function key+1)*16 consequent: 0=F2, 1=FO, 2=F1,... 15=F14 <a href="#">Bit 3 - 0</a> : Ditch light OFF time modification <a href="#">[s]Ditch light off time modification</a>
#393	ZIMO-Config. 5	0 - 255	0	Bit 0 = 1: activate ditch light if bell is played Bit 1 = 1: activate ditch light if horn is played
#190	Fade-in time for 88, 89, 90 effect  from SW version 33.10 (regarding Value 0 from SW version 34)	0 - 255	0	= 0: 0,5 sec. = 1: 1 sec fade-in time = (i.e.) 5: @ 4 sec = 255: @ 320 sec ATTENTION: Above values are valid for a "cycle time" 5 (i.e. CV #63 = 50 ... 59). About 1/6 of the time with cycle time 0; double time with cycle time 9.
#191	Fade-out time for 88, 89, 90 effect  from SW version 33.10 (regarding Value 0 from SW version 34)	0 - 255	0	= 0: invalid value for SW version 33; later 0,5 sec. = 1: 1 sec fade-out time = (i.e.) 5: @ 4 sec = 255: @ 320 sec ATTENTION: Above values are valid for a "cycle time" 5 (i.e. CV #63 = 50 ... 59). About 1/6 of the time with cycle time 0; double time with cycle time 9.
#353	Automatic smoke generator shut-down	0 - 255 = 0 - 106 min	0	For special effect codes "010010xx" or "010100xx" (smoke generator): Overheat protection: turns OFF after ½ min to about 2 hours. = 0: Won't turn off automatically. = 1 ... 255: Switches off autom. after 25 seconds/unit.

### 3.23 Configuration of Smoke Generators (for sound decoders)

#### Smoke generator without fan (Example: Seuthe 18V):

In addition to a simple ON/OFF function via a function output of your choice, the smoke intensity can also be programmed to change between **standstill, or cruising and acceleration**.

This requires the smoke generator to be connected to one of the function outputs **FO1...FO8 (FO7 and FO8 only with SW version 34 or higher)** and the selected output must be programmed for the desired effect with the associated "effect CV" (with CV #127 for FO1, CV #128 for FO2 etc.); in this case for load dependent smoke of steam engines (effect code "72") or load dependent smoke of diesels (effect code "80").

The smoke generator characteristic as defined by CV #137, 138 and 139 is used for the relevant function output. These CV's must be programmed (with appropriate values) otherwise the smoke generator will not produce any smoke.

**EXAMPLE:** - Typical characteristic for a track voltage set around 20V with above smoke generator:  
CV #137 = 70...90: little smoke at standstill.

CV #138 = 200: The smoke intensity is increased to about 80% of its maximum capacity beginning with speed step 1 (at very low speed), which produces relatively heavy smoke.

CV #139 = 255: The smoke generator is driven to its maximum under acceleration, which results in thick smoke.

*Synchronized steam chuffs or typical diesel smoke (with exhaust fan):*

The heating element of the smoke generator is connected – as in the example above with the “Seuthe” generator – on **FO1...FO8** and configured with the appropriate CV for the desired effect (i.e. “72” for steam or “80” for diesel). The fan is connected to the function output **FO4** (in some decoders on **FO2**); see chapter “Installation and wiring”.

CV	Denomination	Range	Default	Description
#133	Use of FO4 as cam sensor output for any sound module or FO4 as exhaust fan of smoke generators of steam engines.	0, 1	0	= 0 (Default): FO4 is used as a normal function output and controlled by a function key, not a cam sensor. = 1: FO4 is triggered by a cam sensor (synchronously to wheel rotation), usually for driving an exhaust fan. This is achieved with either the “virtual” or a real cam sensor. Also see CV’s #267, 268! NOTE: The fan operation is also determined by the sound project. NOTE: Large-Scale decoders (which are not subject of this manual) have special outputs which offer more setting options for fans.
#137 #138 #139	Definition of smoke generator characteristic, connected to FO1 – 8.  <b>NOT for MX621</b>  PWM at stand still PWM at steady speed PWM during acceleration	0 - 255 0 - 255 0 - 255	0 0 0	The values in CV #137 – 139 define a smoke characteristic for the function outputs (FO1 ... FO8; referred to below as FOx), provided a “smoke function” for a diesel or steam engine (value 72 or 80) has been selected in the associated CV #127 – 132:  CV #137: PWM of FOx at standstill CV #138: PWM of FOx at cruising speed CV #139: PWM of FOx at acceleration (PWM = Pulse Width Modulation)
#351	Exhaust fan speed at constant speed For DIESEL engines	1 - 255	128	The fan speed is adjusted by PWM; the value in CV #351 defines the effect at steady speed. = 128: Fan is driven at half the voltage at cruising speed.
#352	Exhaust fan speed at motor starts and during acceleration For DIESEL engines	1 - 255	255	The exhaust fan is set to a higher speed (usually top speed) for generating the typical exhaust puff during motor starts as well during hard accelerations. = 255: Fan receives maximum voltage at start-up or accelerations.
#353	Automatic smoke generator shutdown For STEAM and	0 – 255 = 0 - 106	0	If a smoke generator is controlled by one of the effects “010010xx” or „010100xx” in CV’s #127 to 132 (for one of the function outputs FO1 to FO6), the output turns itself off automatically after the time defined in this CV

	DIESEL engines	min.		#353, in order to protect the generator against overheating. = 0: no automated shut-down = 1 to 255: automatic turn-off after 25sec/unit, which offers a maximum time of about 6300sec = 105min.
(#354)				See chapter 5.5
#355	Exhaust fan speed at stand-still For STEAM and DIESEL engines	1 – 255	0	Supplement to the settings in CV #133 and the effects with code “72” (steam engines) or “80” (diesel engines), where the fan is only set-up for chuff beats or during starts and cruising speeds. With CV # 355, however, the fan speed is adjusted at a standstill, so that even in this state smoke is discharged (to a lesser extent). The sound must be turned ON.

### 3.24 Configuration of Electric Uncouplers

*“System KROIS” and “System ROCO”*

When one or two of the function outputs **FO1...FO8** (FO1... FO6 with software versions below 34) are assigned for the uncoupler function (CV #127 for FO1 etc.), the control of the couplers as well as the entire uncoupling process is defined by the settings in

**CV #115 and CV #116.**

These CV’s limit the pull-in time (to prevent overheating), define a hold-in voltage if required (i.e. System “Roco”) as well as the automated coupler unloading and train disengagement.

It is recommended to use the following settings for the **Krois system: CV #115 = 60, 70 or 80**; these settings will limit the pull-in time (at full track power) to 2, 3 or 4 seconds respectively. A hold-in voltage is not required for the Krois coupler and the ones digit can therefore remain at “0”.

CV	Denomination	Range	Default	Description
#115	Uncoupler control  “Pull-in” time and “hold” voltage or use of CV # 115 for an alternative second dim value (dimming 0-90% using ones digit; tens digit must be 0)	0 - 99	0	The uncoupler function is only active if “uncoupler” is selected (value 48) in one of the CV’s #125 – 132, 159, 160:  Tens digit (0 – 9): Time in seconds the coupler receives full voltage (pull-in time): Value: 0 1 2 3 4 5 6 7 8 9 seconds: 0 0,1 0,2 0,4 0,8 1 2 3 4 5  Ones digit (0 to 9): hold-in power in percent of track voltage, 0 - 90%. Applied after the pull-in time elapsed (necessary for ROCO coupler, not needed for KROIS coupler).

#116	Automatic disengagement after uncoupling  = "Automatic uncoupling"	0 - 99, 0 - 199	0	Tens digit (0 – 9): Length of time the loco should move away (disengage) from the train; coding as in CV #115. Ones digit (0 – 9) x 4 = Internal speed step applied for disengagement (Momentum per CV #3 etc.) Hundredths digit = 0: No unloading. = 1: Coupler unloading: engine moves toward train in order to relieve coupler tension, before uncoupling and disengaging from the train. <u>Example:</u> CV #115 = 61: Loco uncouples and drives away from train for 2 seconds at speed step 4. CV #116 = 155: Loco pushes against train first to unload couplers, uncouples and then drives away from the train for 1 second at speed step 20.
------	--	--------------------	---	---

**Notes to automated uncoupling with coupler-unloading and train disengagement**

- The automatic train disengagement is active if the tens digit in CV #116 is other than 0; if desired with prior coupler unloading (when CV #116 > 100).
- The automatic train disengagement (or the preceding coupler unloading) is started at the same time the coupler is activated, but only if the train is standing still (speed 0); if the train is still moving, the uncoupling, unloading and disengagement procedure won't start until the train comes to a full stop.
- The procedure terminates when the "temporary" function key is released (or pressed again if in latched mode), or when the predetermined times (CV #115 for the coupler, CV #116 for the disengagement) have expired.
- The uncoupling and disengagement process is aborted immediately if the speed regulator is operated at the same time.
- The driving direction for the train disengagement is always according to the cab setting; directional settings in the "special effects" definition for uncoupling (Bits 0 and 1 of CV #127, CV #128 etc.) will not be applied.

**3.25 SUSI-Interface and Logic-Level Outputs (NOT for MX621)**

All decoders described in this manual (except MX621) have outputs that can either be used as a SUSI interface, as logic level outputs or for servo control. These outputs are available at solder pads or on the decoder plug (MTC or PluX), see the various decoder pin-outs starting on page 5.

These outputs are active as SUSI interface by default. To switch them to **logic level outputs**, configure CV #124 as follows:

CV #124 = 128 or +128 (= Bit 7 in addition to other possibly set bits).

These logic level outputs are then always regarded as the next "normal" outputs. For example: The MX630 comes with a total of 6 function outputs (Lfor, Lrev, FO1 – FO4). The two logic level outputs are controlled as FO5 and FO6.

If these outputs are needed for servo control, leave CV #124, Bit 7 = 0 and define CV's #181 and 182 instead (see next chapter "Servo configuration").

CV	Denomination	Range	Default	Description
#124	Shunting key functions:  Changing SUSI outputs	Bits 0 - 4, 6	0	Bits 0 - 4, 6: Shunting key selection and HALF-SPEED ACTIVATOR Bit 5 = 1: " DC stopping" Bit 7 = 0: SUSI is active (or as servo outputs if defined as such in CV's #181 and 182). = 1: Logic level function outputs instead of SUSI
#394	ZIMO Config. 4	Bit 2	0	Bit 2 = 1: I <sup>2</sup> C an SUSI-Interface. This is an OEM feature. For more details contact www.zimo.at

**3.26 Servo Configuration (NOT for MX621)**

CV	Denomination	Range	Default	Description
#161	Servo outputs: Protocol  and alternative use of servo outputs 3 & 4 as SUSI  <b>NOT for MX621</b>	0 - 3 0  Note: CV #161 must be set to "2" for <b>Smart Servo RC-1!</b>	0	Bit 0 = 0: Servo protocol with positive pulses. = 1: Servo protocol with negative pulses. Bit 1 = 0: Control wire only active during movement = 1: ... always active (consumes power, vibrates at times but holds position even under mechanical load) – this setting is also required for <b>SmartServo RC-1</b> (with memory wire)! Bit 2 = 0: For two-key operation, with center position (as per CV #181/182) when both function keys are OFF. = 1: For two-key operation (as per CV #181/182), where the servo runs only as long as function keys are active. Bit 3 = 1: Servo outputs 3 and 4 are used for SUSI Data and SUSI clock (only for decoders that actually have 4 servo outputs).
#162	Servo 1 - Left stop	0 - 255	49 = 1ms pulse	Defines the servo's left stop position. "Left" may become the right stop, depending on values used.
#163	Servo 1 - Right stop	0 - 255	205	Defines the servo's right stop position.
#164	Servo 1 Center position	0 - 255	127	Defines a center position, if three positions are used.
#165	Servo 1 Rotating speed	0 - 255	30 = 3 sec	Rotating speed; Time between defined end stops in tenths of a second (total range of 25 sec, default 3 sec.).
#166 - 169	As above but for Servo 2	#166 left stop, #167 right stop, #168 center position, #169 rotating speed.		
#170 - 173	Servo 3	#170 left stop, #171 right stop, #172 center position, #173 rotating speed.		
#174 - 177	Servo 4	#174 left stop, #175 right stop, #176 center position, #177 rotating speed.		
#181	Servo 1	0 - 28	0	= 0: Servo not in operation

#182 #183 #184	Servo 2 Servo 3 Servo 4  Function assignment	90 - 93  101-114	0 0 0	<p>= 1: Single-key operation with F1 = 2: Single-key operation with F2 and so on to = 28: Single-key operation with F28 = 90: Servo action depends on loco direction: forward = servo left; reverse = servo right = 91: Servo action depends on loco stop and direction: turns right when stopped and direction is forward, otherwise turns left. = 92: Servo action depends on loco stop and direction: turns right when stopped and direction is reverse, otherwise turns left. = 93: Servo action depends on loco movement: turns right when loco stopped, left when loco moving; direction has no effect. = 94: refers to function "Panto1" which is configured in CV#186 = 95: ..."Panto2" configured in CV#187 = 96: ..."Panto3" configured in CV#188 = 97: ..."Panto4" configured in CV#189 = 101: Two-key operation F1 + F2 = 102: Two-key operation F2 + F3 and so on to =127: Two-key operation F27 + F28 = 111: Two-key operation F11 + F12 = 112: Two-key operation F3 + F6 = 113: Two-key operation F4 + F7 = 114: Two-key operation F5 + F8 (Two-key mode as defined with CV #161, Bit 2)</p>
#185	Special assignment for live steam engines		0	<p>= 1: Steam engine operated with single servo; speed and direction controlled with speed regulator, stop is in center position. = 2: Servo 1 proportional, on speed regulator, Servo 2 for direction. = 3: as in 2, but: direction-servo is automatically in "neutral" if speed is 0 and F1 = ON; If speed step &gt; 0: direction-servo is engaged.  NOTE to CV #185 = 2 or 3: Servo 1 is adjustable with CV #162, #163 (end stops); with appropriate values the direction can be reversed as well. Servo 2 is adjustable with CV #166, #167.</p>
#186 #187 #188 #189	"Panto1" "Panto2" "Panto3" "Panto4"		0	<p>Bit 7 = 0: not sound dependent = 1: sound dependent Bit 6 - 5 = 00: direction dependent, = 01: only if loco drives forward = 10: only if loco drives backwards = 11: only if F-key is turned off Bit 4 - 0: key to activate (00001=F1, 00010=F2, 00011=F3,...)</p>

## 4 Feedback - "Bidirectional communication"

All ZIMO decoder types have been equipped with a type of feedback ever since DCC was formed, which has always been a major difference to competitors' products:

- the **ZIMO loco number identification** is part of ZIMO DCC decoders since 1997 and as far back as 1990 with ZIMO's own data format (which is no longer in use today). It can only be used with ZIMO DCC systems (MX1...MX10, MX31ZL, MX32ZL...) and together with ZIMO track section modules (MX9 and successors): After receiving DCC packets, the decoder sends acknowledgment pulses which will be utilized to identify and locate the decoder in the respective section of track.
- all ZIMO decoders are ready for the **"bidirectional communication"** according to **"RailCom"** since 2004; it is operational in newer decoders such as the MX630 and MX640 series from the beginning (basic functions, ongoing expansion with future software updates).



"Bidirectional" means that the information transfer within the DCC protocol is not only flowing towards the decoder but also in the opposite direction; that is, not just driving, function and switch commands are being sent to decoders but also messages such as acknowledgements, actual speed as well as other status information and CV readouts are being received from decoders.

The functioning principle of RailCom is based on the introduction of short cut-outs (max. 500 micro seconds) by the command station to the otherwise continuously sent DCC signal. These cut-outs provide the time and opportunity for the decoders to send a few bytes of data to locally mounted detectors.

Relevant CV's for RailCom configuration:

CV	Denomination	Range	Default	Description
#28	RailCom Configuration	0 - 3	3	Bit 0 - RailCom Channel 1 (Broadcast) 0 = OFF <b>1 = ON</b> Bit 1 - RailCom Channel 2 (Data) 0 = OFF <b>1 = ON</b>
#29	Basic configurations	0 - 63	14 = 0000 1110 Which is Bit 3 = 1 ("RailCom" turned on)	Bit 0 - Train direction: 0 = normal, 1 = reversed Bit 1 - Number of speed steps: 0 = 14, 1 = 28 Bit 2 - DC operation (analog): 0 = off 1 = on Bit 3 - RailCom ("bidirectional communication") <b>0 = deactivated 1 = activated</b> Bit 4 - Individual speed table: 0 = off, CV # 2, 5, 6, are active. 1 = on, according to CV 's # 67 - 94 Bit 5 - Decoder address: 0 = primary address as per CV #1 1 = ext. address as per CV #17+18
#136	Speed feedback correction or km/h - control number during calibration run	RailCom display factor	128	RailCom speed feedback correction factor. or (see chapter 5.8) reading out the result of the internally computed speed after the calibration run.

CV	Denomination	Range	Default	Description
#158	Several special bits + RailCom variants	0 - 127	4	<p>ATTENTION: all other bits in this CV are used for a variety of different special sound settings.</p> <p>Bit 2 = 0: RailCom speed (kph) – feedback using the "old" method (for MX31ZL ! Id 4)</p> <p>= 1: RailCom speed (kph) – feedback using the new STANDARDIZED method (Id 7).</p>

With the help of **bidirectional communication** according to RailCom

*decoders will acknowledge received commands -*

- which increases operational reliability and the bandwidth of DCC systems because already acknowledged commands don't need to be sent repeatedly;

*current decoder data is sent to the command station ("global detector") -*

- e.g. "real" (measured) train speed, motor load, routing and position codes, "fuel reserves", current CV values on demand from decoders is sent to the command station or more precisely, to a **global detector** in the command station;

*decoder addresses are recognized by "local" detectors -*

- the actual loco positions are determined by local detectors connected to individual track sections (integrated in future MX9 track section modules, later StEin), which has been possible with ZIMO's own loco number recognition for a long time, even without RailCom.

RailCom will be further developed over the coming years and new applications added, which of course requires new software updates in decoders and other equipment. ZIMO decoders as of 2009 are able to send their own loco address from an isolated section of track (with a so called broadcast method, very fast, although only for one loco inside that section), send CV content on demand along with some decoder data such as actual speed in kph, load and decoder temperature.

On the system side, only one third party product has been available from the beginning – the address display LRC120, which is a "local" RailCom detector displaying the loco address on one track section. In 2007, the ZIMO MX31ZL came to market as the first command station with an integrated "global" RailCom detector.

Since 2013, ZIMO delivers the new MX10 command stations with integrated detectors for RailCom. The MX32 cab (released early in 2011) uses feedback functions from the start (speed indicator, CV-reading), but until the appearance of the MX10 is accessible only in connection with the MX31ZL.

RailCom is activated in ZIMO Decoders with

**CV #29, Bit 3 = 1 AND CV #28 = 3**

These are usually default settings on a new decoder, but RailCom is turned off by default in many sound projects or OEM CV sets and must therefore be activated first with above CV's (see table above).

ATTENTION (if speed-feedback does not work): see CV #158, Bit 2 (in table above).

"RailCom" is a registered trademark of Lenz Elektronik GmbH.

## 5 ZIMO SOUND – Selection and Programming

### Sound projects, Sound Collections, free and fee-based projects etc.

Specialties of the ZIMO sound organization over the traditional offerings from other manufacturers

► Each sound decoder requires a **sound project in the decoder's flash memory**. The sound project is basically a file, composed of the sound samples of a real locomotive (or several locomotives in the case of the "Sound Collection", see below), as well as playback instructions (in the form of schedules, dependencies on operating condition, speed, acceleration, pitch, etc.) and assignments (to function keys, random generators, switch inputs, etc.).

► Each ZIMO decoder comes loaded with a sound project (usually a "sound collection", see below). Other ZIMO sound projects for installation by the user can be downloaded from the ZIMO sound database at [www.zimo.at](http://www.zimo.at) in the form of "**Ready to use**" projects (.zpp file) and often, in addition to that, as "**Full featured**" projects (.zip file):

The "Ready to use" project is a **.zpp file**, which after downloading is uploaded to the decoder with the help of decoder update modules such as the MXDECUP, MXULF, MX31ZL or MX10 command station. The file is placed on a flash drive which is then plugged into the USB host socket of the mentioned modules or sent from a computer (connected to the USB client socket with the software **ZSP** installed on the PC) to the decoder. After the sound upload, many assignments and settings can be changed to suit individual tastes (even though it is a "ready-to-use" project), using the procedures and CV's described in the decoder manual.

The "Full featured" project on the other hand is a **.zip file** as downloaded from the sound database; it cannot be uploaded to the decoder directly but can only be unzipped and edited with the help of the "**ZIMO sound programmer**" **ZSP**. Assignments and settings can be determined within ZSP and it is also possible to remove sound samples for external processing or exchange them with others; it is therefore possible to create your own or highly individualized sound projects. The result is again a **.zpp file** that can be uploaded to the decoder.

► ZIMO sound decoders are delivered preferably with a "**Sound collection**"; this is a special type of a sound project: sound samples and CV parameters for several engines (i.e. for 5 engines) are stored on each decoder. The preferred sound for a given locomotive can be selected with the cab (no need to load a different sound sample from the computer). (CV#265)

The user is free to change acoustics of a locomotive to his/her own taste by combining for example a chuff sound from 5 different chuff samples and one or several whistles (selection is made using the "CV #300" procedure); equally select from bells, compressors, coal shoveling, oil burners or break squeals etc.

Note: Even normal sound projects ("normal" = for a specific locomotive) can comprise the characteristics of a "sound collection", by containing several whistles for example from which one can be selected using the "CV #300 procedure".

► Among the sound projects available from the ZIMO sound database, it must be distinguished between the

- "**Free D'load**" (= no charge) sound projects, often produced by ZIMO and the
- "**Coded**" (= purchased) sound projects, from external sound providers.

The "Coded sound projects" are contributed by external ZIMO partners (= providers, for example by Heinz Däppen from the Rhaetian Railway and American steam locomotives), who get reimbursed by the sale of "load codes". These fee-based projects can be downloaded for free from the ZIMO Sound Database, but can only be used in "**coded**" decoders, i.e. those in which the appropriate "**load code**" has been programmed beforehand. "Encoded decoders" can be purchased with the "load

code" pre-installed (subject to a charge, see price list) or the load code is purchased later and entered to the appropriate decoder CV's (CV's # 260, 261, 262, 263). The "load code", which authorizes the use of sound projects of a specific sound supplier (i.e. the sound projects of Heinz Däppen) applies to one specific decoder which is identified by its decoder ID (CV 250, 251, 252, 253).

► In addition to the "Free D'load" and "Coded" projects, both of which are ready for download on the ZIMO Sound Database (see above), there is also the

- **"Preloaded" sound projects**; these are exclusively available as pre-programmed decoders and this in turn often only installed in new locomotives. "Preloaded" sound decoders are usually not provided by Zimo, but by model railroad manufacturers and distributors, who are also responsible for setting the prices. These sound projects are merely listed in the ZIMO Sound Database as reference.

### Decoders with sound collection – How to select a loco type with CV #265

using the example of the "European steam/diesel collection":

CV	Denomination	Range	Default	Description
#265	Loco type selection	1	1 or 101	= 0, 100, 200: Reserved for future applications
		2	Steam = 1	= 1, 2 ... 32: Select among various steam sounds stored in the decoder, i.e. for loco BR01, BR28, BR50, etc... Chuff sounds as well as other sounds (whistle, compressor, bell...) will be matched.
		...		
		101		
		102	Diesel = 101	= 101, 102 ... 132: Select among various diesel engines (if several diesel sounds are in the collection).
...				

### Operating the sound decoder for the first time

with "European steam/diesel" sound collection:

As delivered, the decoder comes with a typical engine sound activated and function-sounds allocated to function keys:

#### Function F8 – Sound ON/OFF

sounds played back with a function key remain active regardless whether F8 is on or off (a separate function key can be assigned with CV #311 to turn the function sound ON/OFF, which could of course also be F8!)

By default, the "European steam/diesel collection" plays back the sound of a 2-cylinder engine (the chuff rate can only be approximate without further tuning) with automated water drainage and brake squeal as well as some randomly played stationary sounds.

The **function keys** are allocated to the following function sounds:

F2 – short whistle	F7 – coal shoveling or oil burner
F4 – water drain (blow off...)	F9 – compressor
F5 – long whistle (playable)	F10 – generator
F6 – bell	F11 – injector

The **random sound generators** to ... stationary sounds:

Z1 – compressor	Z2 – coal shoveling	Z3 – injector
-----------------	---------------------	---------------

The **switch inputs**:

S1 – nothing	S2 – nothing	S3 – nothing
--------------	--------------	--------------

### A sound project is composed of...

... sound samples, schedules and CV settings.

To produce the sound of a locomotive, the sound project contains the following components:

- 1) the **"main engine" sound**: this is the central sound, such as the chuff or diesel engine sound, or the cooling fan (which is the key sound in electric locomotive projects). This "main engine" sound is the only sound component associated with a **schedule**, which defines important properties, especially the transitions between different sound samples in various speed, acceleration and load situations. This schedule can only be changed in the "ZIMO Sound Programmer" ZSP, not by CV's. However, there are numerous possibilities for **fine-tuning** the main engine sound **through CV's** (e.g. relation between chuff frequency and speed, lead-chuff accentuation, coasting/notching functions, etc.)
- 2) Other **scheduled sounds** (often inaccurately called background sounds): these are boiling, draining, turbocharger or brake squealing sounds and many others; also in the case of electric locomotives the actual primary sounds of the thyristor unit and the electric motor. "Scheduled" sounds - both the "main engine" and "other" - are characterized in that the decoder plays them automatically, based on the driving situation, while the "function sounds" (see below) are activated with the cab's function keys. These "other" -sounds (i.e. all except the "main engine" sound, see above) are NOT played according to a schedule, i.e. they are **fully defined by CV's, and can be modified** directly by the relevant CV's or CV # 300 - procedures, even in operation (speed, load dependence, etc.). Only the underlying original recordings, that is, the sound sample or a selection of samples, is stored in the sound project (or in the sound collection).
- 3) The **function sounds**, which are played back by pressing the corresponding function keys includes acoustic signals such a whistles, horns, bells but also other sounds like coal shoveling, coupler clank, lowering of pantographs as well as station announcements. The volumes of each sound and whether it is "looped" (for continuous playback as long as the function key is pressed) is **defined by CV's** but can also be **modified by these CV's** or with the CV #300 procedure. Here too, only the sound samples of the project or selections of several projects are predefined.
- 4) and 5) the **switch input** and **random sounds** are normally sounds that can also be used as function sounds but are triggered by switch inputs or random generators.

The occasionally used term "driving sound" refers to a subset of all the sounds, namely the "main engine" sound and most of the "other" sounds; the "departure whistle" sound for example is not included because it is not dependent on driving data.

### 5.1 The "CV #300 procedures" only if address is NOT 3!

A more convenient procedure (w/o manual CV #300 programming) is available with MX31/MX32 cabs

The term "CV # 300 - procedure" means the "pseudo-programming" of CV # 300, which allows the **modification of the currently loaded sound project** during normal operation, in relation to:

- the **selection** of sound samples within the various sound groups (i.e. "short whistle"), if it is a "sound collection" (which has several sound samples in some of its sound groups) or a "normal" sound project with several sound samples in certain groups.
- the **volume** and the sound **loop** behavior of individual sounds; for example, setting the whistle volume different to the driving sound volume (i.e. chuff beats).

All CV #300 procedures must be done in operations mode (on the main), NOT in service mode!

**NOTE:** If setting the volume of individual sound classes is the main concern, it is more convenient to use the direct CVs, see chapter "Drive-independent basic settings"; in many applications the CV #300 procedure is therefore NOT needed.

#### Selecting a chuff set (if several sets are present in a sound collection):

(only possible for steam projects, not for diesel or electrics)

The following procedures are always used in the same way in spite of the flexible decoder layout with different sound sample compilations. It is also worth mentioning that the sound samples can be listened to and evaluated under actual operating conditions (with the engine running), not just on the computer.

The **selection procedure** is started with a "Pseudo-Programming" in operations mode ("on-the-main"):

**CV #300 = 100 (only for steam / not possible with DIESEL engines!).**

The "Pseudo-Programming" (meaning that the entered value is not really stored in memory) has the effect that the **function keys F0 to F8** no longer actuate function outputs but instead are now available for **special tasks** within the sound selection procedure. The function keys should be set to momentary, if possible, which would facilitate the procedure. **CV #300 procedures must be done in operational mode (on the main), NOT in service mode!**

The function key identifications (and the MX31/MX32 cab displays) shown are typical for a ZIMO cab during the selection procedures (and for other sound adjustment procedures) but **is analog to the function keys of third party cabs**, although the keyboard layout may be different.

The function keys have the following special meaning during the selection procedure!

ZIMO cab MX31 key arrangements:

- 1 F0   2 F1   3 F2
- 4 F3   5 F4   6 F5
- 7 F6   8 F7   9 F8

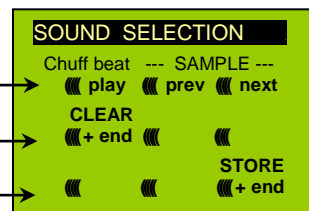

**F0** = play: plays back the current chuff sound for evaluation; only possible with the engine at a standstill; the chuff sounds are played back automatically when the engine is moving.

**F1, F2** = prev, next : plays back the previous or next recording stored in the decoder; the sound file can immediately be evaluated with the engine stopped, whereas with the engine running the selected file immediately replaces the currently active.

**F3** = CLEAR + end : The **selection procedure** is **stopped** and the selection is cleared, that is no chuff sound will be played (but boiling and blow-off sound remains).

**F8** = STORE + end : The **selection procedure ends** and the current chuff set is replaced with the selected chuff set.

The **selection procedure** is also stopped when programming anything else (e.g. **CV #300 = 0**, or any other value or any other CV) or by interrupting power. In these cases, the **current chuff set remains**. Such "forced endings" are also useful when the "old" sound should remain as the current sound without first having to locate it again.

The selection procedure is supported with **acoustic signals**:  
The "**cuckoo jingle**" sounds when....

- .... the last stored chuff sound is reached; use the key to scroll in the opposite direction (F1, F2) to listen to the other stored chuff sounds,
- .... playback is tried (F0) but no sound sample is assigned,
- .... a wrong key is pressed (F4, F5 etc.)

The "**confirmations jingle**" is played after ending the selection procedure with F3 or F8.

The engines can be **operated normally** during the selection procedure: with speed regulator, direction key and MAN key (the latter only with ZIMO cabs); functions cannot be actuated until the selection procedure is terminated with F3, F8 or by other programming steps, see above.

#### Selecting boiling, whistle, blow-off, brake squeal sounds...

within a sound collection or a sound project with several samples of this kind/for these classes:

The **selection procedures** for these "automated background sounds" are initiated with an operational mode "Pseudo-Programming"

**CV #300 = 128** for the boiling sound (steam only)

**CV #300 = 129** for direction-change sound

**CV #300 = 130** for the brake squeal

**CV #300 = 131** thyristor-control sound (electric engine)

**CV #300 = 132** for the "start" whistle or horn

**CV #300 = 133** for blow-off sound =cylinder valves (STEAM only)

NOTE: the blow-off selection (CV #300 = 133) is also valid for function key playback (CV #312).

**CV #300 = 134** for the driving sound of ELECTRIC engines

**CV #300 = 135** for rolling noise

**CV #300 = 136** for the switchgear sound of ELECTRIC engines

**CV #300 = 137** for a second Thyristor sound (ELECTRIC engines)

**CV #300 = 141** for the turbo charger (DIESEL engine)

**CV #300 = 142** for the "dynamic brake" (Electric brake, ELECTRIC engines)

The selection procedure for background sounds is the same as for the selection of chuff sounds. EXCEPT: the engine should be at a **standstill** because the **speed regulator** is used for **setting the volume** of the relevant sound file!

Note: these sound files can also be used as function sounds, allocated to function keys (see next page); the automated back-ground sounds can then be cancelled with the function keys.

The function keys have the following special meaning during the selection procedure; speed regulator is used for volume setting!

ZIMO MX31 key arrangement  
 ☞ 1 F0 ☞ 2 F1 ☞ 3 F2  
 ☞ 4 F3 ☞ 5 F4 ☞ 6 F5  
 ☞ 7 F6 ☞ 8 F7 ☞ 9 F8

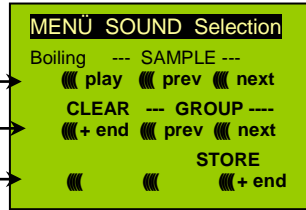

Function keys are used as with chuff selections:

**F0** = play : plays back the currently selected sound.

**F1, F2** = prev, next : plays back the previous or next recording.

**F4, F5** = prev, next : switches between sound groups

The **speed regulator** acts as volume control for the background sound during the selection procedure.

**F3** = CLEAR + end : **Selection procedure is stopped** and the current sample removed.

**F8** = STORE + end : **Selection procedure is stopped** and the new selection activated.

The **selection procedure** can be **ended** by any other programming procedure or by removing power. Functions cannot be actuated during this procedure!

*A more convenient procedure (w/o manual CV #300) is available with MX31/MX32 cabs*

**Allocating sound samples to function keys F1 ... F19**

within a sound collection or a sound project containing several samples per group:

A sound sample can be allocated to each function key F1...F19 from the sound samples stored in the decoder. It is absolutely permissible to have a function key assigned for a function output (FO1, FO2 etc.) as well as for a sound function, both of which will be activated when the key is pressed.

The **allocation procedure** for function sounds are initiated with a "Pseudo-Programming" in operations mode programming:

- CV #300 = 1 for function F1
- CV # 300 = 2 for function F2
- etc.
- CV # 300 = 20 for function F0 (!)

Note: Function F4 is by default used for water drainage sound (with CV #312); if F4 is to be used for something different, CV #312 must be set to zero (CV #312 = 0).

The allocation procedure is very similar to the selection procedures for driving and background sounds, with the difference that sound allocation is not limited to sound samples of a certain group but also allows switching between groups to find the desired sample.

Sound samples are organized in **groups** for easier location; i.e. groups like "short whistle" / "long whistle" / "horn" / "bell" / "shoveling coal" / "announcements" and much more.

The engine should remain **stationary**, since the **speed regulator** is used for **volume settings** during the allocation procedure!

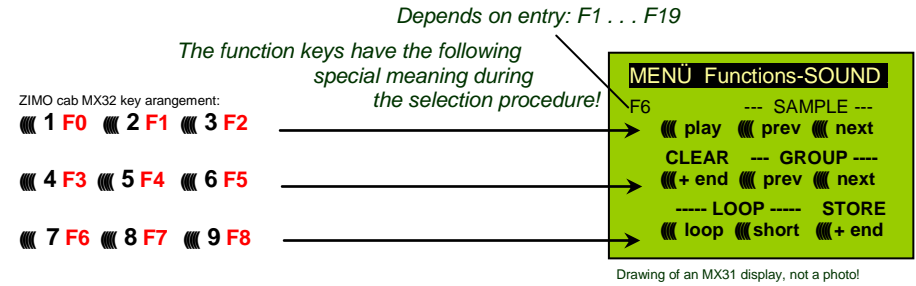

**F0** = play : plays back the current sound file for evaluation.

**F1, F2** = prev, next : plays back the previous or next recording stored in the decoder.

**F4, F5** = prev, next : switches between sound groups (e.g. whistles, bells etc.); starts playback with the first sample of this group.

The **SPEED REGULATOR** acts as volume control for the selected sound during allocation procedure.

**F6** = loop : If F6 is "on" when exiting the allocation procedures, the sound sample is stored and played back as long as the relevant function key is pressed by repeating the sound between the loop markers (the loop marks are part of the sound file).

*Playable whistle!*

**F7** = short: If F7 is "on" when exiting the allocation procedures, the sound sample is shortened and played back only as long as the function key is pressed, by omitting the center portion.

Note: F6 and F7 are only effective provided the loop markers are included in the sample; basic settings are also saved; changes take effect only if F6/F7 is actuated.

Note: If F6 and F7 are not actuated, the sound sample will always be played back in the same length it was saved, regardless how long the function key is pressed.

**F3** = CLEAR + end: The **allocation procedure is stopped** and the current sound removed. There will be no sound allocated to this function key.

**F8** = STORE + end: The **allocation procedure is stopped** and the last selected function sound is stored and ready for playback when this function key is pressed.

The **allocation procedure** can also be **ended** by any other programming procedure (e.g. CV #300 = 0 or any other value or CV) or by removing power from the decoder. The "old" allocations remain active in such cases; such "forced endings" are also useful when the "old" sound should remain as the current sound without first having to locate it again.

The selection procedure is supported with **sound signals**:

The "**cuckoo jingle**" sounds when...

.... the last stored sound sample of a group is reached; use the appropriate key (F1, F2) to scroll in the opposite direction to listen to the other stored sounds,



.... the last stored sound group is reached (with F4 or F5); use the appropriate key (F4 or F5) to scroll in the opposite direction.

.... play-back attempted (with F0) but no sound sample is available,

.... a wrong key is pressed.

The “confirmations jingle” is played after ending the allocation procedure with F3 or F8.

**Allocation of sound samples to the random generators Z1...Z8:**

MX640 decoders provide 8 simultaneously playing random sound generators. The timing of them is determined by CV's; see “CV table” from CV #315.

A sound sample can be added to each random generator from the pool of samples in the decoder.

The **allocation procedure** for random sound is initiated with a “Pseudo-Programming” in operations mode programming:

- CV #300 = 101 for random generator Z1  
(Z1 has special logic incorporated for the compressor and should therefore always be used for that)
- CV #300 = 102 for random generator Z2
- CV #300 = 103 for random generator Z3
- etc.

*Depends on entry: Z1 . . . Z8*

*The function keys have the following special meaning during the selection procedure!*

ZIMO MX31/MX32 key arrangement:

- 1 F0 2 F1 3 F2
- 4 F3 5 F4 6 F5
- 7 F6 8 F7 9 F8

**MENU Random-SOUND**

Z2 --- SAMPLE ---

play prev next

CLEAR --- GROUP ---

+ end prev next

--- LOOP --- STORE

still cruise + end

The meaning and action of the function keys is the same as for function sounds (see above):

**F0** = play: playback

**F1, F2** = prev, next: playback of previous or next sound sample etc.

but

**F6** = still: If F6 is active when ending the allocation procedure, the sound sample is played as random sound at standstill only (default).

**F7** = cruise: If F7 is active when ending the allocation procedure, the sound sample is played as random sound when the locomotive is moving.

The allocation procedure for random sound is the same as for function sound!

**Allocation of sound samples to switch inputs S1 and S2:**

The MX640 has 3 switch inputs available, of which two (“1” & “2”) are freely available to the user while one (“3”) is usually reserved for a cam sensor input; which can also be used for other inputs if not used for a cam sensor (i.e. the virtual cam sensor is used instead). These inputs can accept reed switches, optical or hall-effect sensors and similar; see chapter 8: “Connecting speaker, cam sensor”.

A sound sample can be allocated to each switch input, from the pool of stored samples in the decoder; playback times can be set with the help of CV's #341, 342 and 343, see CV table.

The switch input **allocation procedure** is initiated with the operations mode Pseudo-Programming

- CV #300 = 111 for switch input S1
- CV #300 = 112 for switch input S2
- CV #300 = 113 for switch input S3
- and so on...

*Depends on entry: S1...S4*

*The function keys have the following special meaning during the selection procedure!*

ZIMO MX31 key arrangement:

- 1 F0 2 F1 3 F2
- 4 F3 5 F4 6 F5
- 7 F6 8 F7 9 F8

**MENU Switch-SOUND**

S1 --- SAMPLE ---

play prev next

CLEAR --- GROUP ---

+ end prev next

--- LOOP --- STORE

still cruise + end

The meaning and action of the function keys is the same as for function sounds (see above):

**F0** = play: playback

**F1, F2** = prev, next: playback of previous or next sound sample etc.

## 5.2 “Incremental Programming” of sound CV’s, an alternative to “normal” programming

Configuration variables (CVs) for optimizing sound effects can of course be programmed in the conventional manner by changing CV values using the cab in service mode (on the programming track) or in operational mode (on the main track), but many can alternatively also be programmed by

“Incremental” programming.

This method is not suitable for CVs where individual bits need to be set independently.

The “incremental programming” is a special process of the “operational mode” programming with the following fundamental principle: the CV’s are not programmed with an absolute value (as is normally the case) but rather the current value of a CV is being incremented or decremented by a fixed value (defined in the decoder for each CV).

The function keys of the cab temporarily serve as instruments for the incremental programming, which means they cannot be used for function output actuations during that time. The function keys are temporarily assigned for this task with the “Pseudo-Programming”

**CV #301 = 66,**

which changes the function keys to INC and DEC keys, first for CV #266 (that is the CV number derived from the value + 200).

Several CV’s are grouped together in one procedure for an easier and better handling. In the case of CV #301 = 66, the leading CV #266 (“Lead-CV”) is assigned for incremental programming as well as CV #267 and #268.

This is again shown here by means of the ZIMO cab with the special MX31 display, but is valid analogous for the function keys of other cabs.

*The function keys have the following special meaning during the selection procedure!*

ZIMO MX31 key arrangement:

**F0** **F3** **F6**    **F1** **F4** **F7**    **F2** **F5** **F8**  
**4** **F3**    **5** **F4**    **6** **F5**  
**7** **F6**    **8** **F7**    **9** **F8**

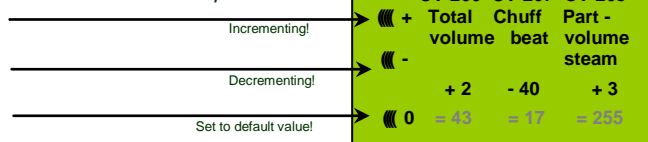

Drawing of an MX31 display, not a photo!

The last line shown in gray (absolute CV values) will not be available until bidirectional communication is being implemented!

**F0, F3, F6** Incrementing, decrementing and default setting of the lead CV number that was entered during the “Pseudo-Programming” initiation CV #301 = ... (or via menu with the MX31).

**F1, F4, F7** Incrementing, decrementing and default setting of the second CV number of that group; which CV’s that are part of a group is shown in the CV table or is indicated in the ZIMO MX31 cab display.

**F2, F5, F8** Incrementing, decrementing and default setting of the third CV number of that group (if the group includes 3 CV’s).

The incrementing and decrementing of CV values (usually in the 0..255 range) takes place in steps of 1, 5, 10 or 15; this is predefined by the decoder software and cannot be changed. Intermediate values can be entered by direct CV programming, which in reality is hardly necessary.

The “cuckoo jingle” sounds when....

... the upper or lower end of a CV value range is reached!

If RailCom is not available (because the system used is not equipped with RailCom), the value of a particular CV can only be determined by reading it out on the programming track. Although, most of the time this is not necessary since the reaction to a changed CV value can immediately be heard by the changing sound.

Note: With the MXDECUP update module it is possible to read-out and write complete CV and parameter sets and if necessary edit them on a computer!

## 5.3 The test run for determining the motor’s basic load

The following procedure enables the (subsequent) adjustment of driving sound to engine load (i.e. inclines, pulling weight...), such as steam chuffs (volume and sound) with the CV’s #275, 276...

Technical background:

The load-dependent sound is based on EMF (Electro Motive Force) measurements inside the decoder, which is primarily used for keeping the motor speed constant during load changes. Before the decoder can produce the correct sound for the respective driving conditions it has to know first what these measurements are at normal “no-load” cruising speed (smooth rolling of the engine or train on straight and level track). This “basic load” of an engine or train is often considerably higher on model trains than on the real railroad, which is due to gearbox losses, power pick-ups etc. Deviations from this “basic load” will then be interpreted as inclines or declines, which triggers appropriately modified chuff sounds.

Initiated by “Pseudo-Programming” in Operational Mode

**CV #302 = 75**

an automated test run is performed to record the “basic load” factor in forward direction;

ATTENTION: the engine (or train) is **driven automatically** in forward direction for which unoccupied track must be available of **at least 5 meters (15 feet)**, with absolutely no inclines or declines and without any (tight) curves.

With

**CV #302 = 76**

an automated recording run is performed in reverse direction, for locomotives that have different “basic loads” in this direction (otherwise, the basic load in reverse is considered identical to forward).

The measured results are stored in **CV’s #777 and 778** (slow/fast PWM values, forward) and **#779 and 780** (PWM values in reverse direction); these CV’s can be read out and used as needed for other vehicles, or used as base for further tests.

Note: A “heavy” train (a train with higher rolling resistance due to power pickups of lighted coaches for example) may have a different “basic load” than an engine with nothing on the hook. A separate recording run may be required for such situations in order to obtain the best load dependent sound.

## 5.4 Basic settings independent of powertrain

The CV’s in the following table have the same meaning for all types of power (Steam, diesel, electric):

**NOTE:** The **default values** of individual CV’s are **NOT decoder-specific**, but rather depend on the decoder’s **sound project**. This means that a HARD RESET with CV #8 = 8 returns the decoder to the state defined by the sound project. The default values listed below are values often used in sound projects, but not necessarily the correct values in all cases.

CV	Denomination	Range	De- fault	Description
#265	Select loco type			For sound collections; see first page of this chapter
#266	Total volume	0-255 = 0-400%	64 = 100%	The default value "64" results in the (mathematically) highest possible distortion-free playback volume; but values of up to 100 may nonetheless be practical. <b>Recommended: #266 = 40...90</b>
#395				Maximum volume the sound can be raised to (does not have to be the same value as in CV #266)
#396				Defines function key for volume decrease; lowers volume as long as key is pressed; about 10 steps/sec, down to 0. ATTENTION: This changes CV #266.
#397				Defines function key for volume increase; raises volume as long as key is pressed; about 10 steps/sec, to the maximum defined in CV #395. ATTENTION: This changes CV #266; can be used as a substitute for a mute key.
#310	ON/OFF key for engine <u>and</u> random sound	0 - 28, 255	8	Defines the function key (by default F8) that turns the engine sound (chuffs, boiling, blow-offs, brake squeals...) as well as the random sound (compressor, coal shoveling...) ON or OFF. = 8: F8 key switches driving sound ON or OFF. Note: this is the default key for ZIMO original sound projects; OEM projects (i.e. ROCO) often use other settings. Most often 1 for the F1 key. = 1...28: ON/OFF key for F1...F28. = 255: engine and random sounds are always ON. (If not, change CV #313!).
#311	ON/OFF key for function sound	0 - 28	0	Function key assigned as ON/OFF key of function sounds (i.e. F2 – whistle, F6 – bell etc.). = 0: <u>does not mean</u> that F0 is assigned for this task but rather that the function sounds are always active. = (#310), if the same value is entered here as in CV #310, the key defined in #310 turns <u>all</u> sound ON/OFF. = 1 ... 28: Separate ON/OFF key for function sound.
#312	Blow-off key	0 - 19	4= F4	See chapter 5.5 "Basic steam engine settings". (does not belong in this chapter, despite the correct number sequence)
#313	Mute key	0 - 28 101 - 128	8	This CV assigns a function key with which the driving sounds can be faded in and out, i.e. when the train disappears behind scenery. F8 is used by default, which is already the sound on/off key but now does so softly. = 0: No mute key or mute function. = 1...28: Selected function key F1...F28 as mute key. = 101...128: Assigned function key with inverted action.
#314	Mute –	0 – 255	0	Time in tenths of a second for sound fading in/out when mute

CV	Denomination	Range	De- fault	Description
	fade in/out time	= 0 – 25 sec		button is pressed. Total range is 25 seconds. = 0 (to 10): minimum time setting of 1 sec. = 11...255: longer "fade" times
#376	Driving sound volume	0 – 255 = 0 - 100 %	255 = 100 %	To reduce the driving sound volume (E.g. Diesel motor with related sounds such as turbo charger) compared to the function sounds.

The following CV's can be programmed both "normal" (i.e. CV #... = ...) and "incremental". "Incremental programming" is especially useful when the proper value cannot be calculated in advance and must be determined by trial, which is often the case with sound parameters.

The "Lead CV" in each case is the first of a group of 3 CV's, which are edited and displayed together on a ZIMO MX31/MX32 cab during the "incremental programming" procedure.

CV	Denomination	Range	INC- Step	De- fault	Description
<b>LEAD - CV #287</b>	Brake squeal threshold	0 – 255	10	20	The brake squeal should start when the speed drops below a specific speed step. It will be automatically stopped at speed 0 (based on back-EMF results).
#288	Minimum driving time before brake squeals	0 - 255 = 0 - 25 sec	10	50	The brake squeal is to be suppressed when an engine is driven for a short time only, which is usually a shunting run and often without any cars (in reality it is mostly the cars that are squealing not the engine itself!). Note: Brake squeal sounds can also be assigned to a function key (see allocation procedure CV #300 = ...), with which the brake squeal can be started or stopped manually!
#307	Brake squeals-order Reed configuration			0	Bit0 - Reed1 activates braking squeal Bit1 - Reed2 activates braking squeal Bit2 - Reed3 activates braking squeal Bit3 - Reed4 activates braking squeal Bit7 - 0 = key defined in CV308 suppresses braking squeal of Reed inputs if this key is ON 1 = key defined in CV308 activates braking squeal independent of Reed inputs
#308	Brake squeal-key	0-28		0	0 = no key defined. Reed inputs always active. 1-28 = key F1 to F28.
#133	Reed config.			0	Bit 4 – inverts the polarity of Reed input 1 Bit 3 – inverts the polarity of Reed input 2 Bit 2 – inverts the polarity of Reed input 3 Bit 5 – inverts the polarity of Reed input 4

NOTE: If a decoder comes with a **potentiometer for volume control** (mostly on large-scale decoders), the pot meter should NOT be fully opened if full volume is not really desired (Loss of sound quality if pot meter is fully open and at the same time the volume is heavily reduced by CV's!).

The volume for background sounds (boiling, brake squealing etc.), function sounds, random sounds and switch input sounds can be set within the sound selection procedures (see chapter 5.1 The "CV #300 procedures).

**More convenient** however is the direct volume adjustment by CV's (especially when no sound selection is necessary, which is often the case). Of course, not all sounds listed below are part of every sound project. Changing sound CV values of sound files that are not part of the relevant sound project have no effect.

#### Background sounds - Volume adjustments:

#574	Boiling	0 - 255	0	Boiling volume
#576	Directions change	0 - 255	0	Directions change volume
#578	Brake squeal	0 - 255	0	Braking squeal volume
#580	Thyristor sound	0 - 255	0	Thyristor sound volume (ELECTRIC engine)
#582	Start whistle/horn	0 - 255	0	Start whistle/horn volume
#584	Blow-off	0 - 255	0	Blow-off volume (STEAM engine)
#586	Electric motor	0 - 255	0	Electric motor volume (ELECTRIC engine)
#588	Driving sounds	0 - 255	0	Driving sounds volume (rolling/wheels)
#590	Switch gear	0 - 255	0	Switch gear volume (ELECTRIC engine)
#592	Second Thyristor	0 - 255	0	Second Thyristor volume (ELECTRIC engine)
#594	Panto up	0 - 255	0	Pantograph up volume (ELECTRIC engine)
#596	Panto down	0 - 255	0	Pantograph down volume (ELECTRIC engine)
#598	Panto stop (down)	0 - 255	0	Pantograph stop (down) (ELECTRIC engine)
#600	Turbo	0 - 255	0	Turbocharger volume (DIESEL engine)
#602	Dynamic brakes	0 - 255	0	Dynamic brake volume (ELECTRIC engine)

Note: The CV ahead of the CV's listed (#573, 575 etc.) contain the sound sample numbers to be played.

#### Function sounds - Volume adjustments:

CV	Denomination	Range	De- fault	Description
#571	Function sound F0	0 - 255 = 100, 1-100 %	0	Sound volume operated with function key F0 = 0: full volume, original sound sample volume (same as 255) = 1 .. 254: reduced volume 1 - 99,5 % = 255: full volume
#514	Function sound F1	0 - 255	0	Volume for function sound F1
#517	Function sound F2	0 - 255	0	Volume for function sound F2
#520	Function sound F3	0 - 255	0	Volume for function sound F3
#523	Function sound F4	0 - 255	0	Volume for function sound F4
#526 - #568	Function sound F5-F19	0 - 255	0	Volume for function sound F5 - F19

#674, #677...#698 = volume for sounds on F20, F21...F28.

Note: The CV's between the above (#570, 572, #513, 515, 516, 518 etc.) hold information for the relevant sound samples (sample numbers, loop parameters etc.), which can also be modified if needed, usually with the CV #300 procedures.

#### Switch input sounds - Volume adjustments:

#739	Switch input sound S1	0 - 255 = 100, 1-100 %	0	Volume setting for the sound activated by switch input S1. = 0: full volume, original sample volume (same as 255) = 1 .. 254: reduced volume 1 - 99,5 % = 255: full volume
#741	Switch input sound S2	0 - 255	0	Volume setting for the sound activated with switch input S2
#743	Switch input sound S3	0 - 255	0	Volume setting for the sound activated with switch input S3

Note: The CV immediately ahead of the CV's listed (# 740, 742) contains the sound sample numbers to be played.

#### Random sounds - Volume adjustments:

#745	Random sound Z1			Volume setting for sound activated by random generator Z1
#748 - #763	Random sound Z2 - Z7			Volume setting for sound activated by random generator Z2 - Z7
#766	Random sound Z8			Volume setting for sound activated by random generator Z8

Note: The CV immediately ahead of the CV's listed (#744, 747 etc.) contain the sound sample numbers to be played.

#### Connection between sounds and function output

#726	Connection 1 sound			Soundnumber which shall be valid for connection 1
#727	Connection 1 FA			Function output which shall be valid for connection 1. 1=FA0v, 2=FA0r, 3=FA1,.....
#728	Connection 2 sound			Soundnumber which shall be valid for connection soll
#729	Connection 2 FA			Soundnumber which shall be valid for connection 2. 1=FA0v, 2=FA0r, 3=FA1,.....
#730 ... #735	...			...
#736	Connection 6 sound			Soundnumber which shall be valid for connection 6
#737	Connection 6 FA			Soundnumber which shall be valid for connection 6. 1=FA0v, 2=FA0r, 3=FA1,.....

## 5.5 Steam engine → Basic sound settings

The following CV's can be programmed both "normal" (i.e. CV #.. = ...) and "incremental". "Incremental programming" is especially useful when the proper value cannot be calculated in advance and must be determined by trial, which is often the case with many sound parameters.

The "Lead CV" in each case is the first of a group of 3 CV's, which are edited and displayed together on a ZIMO MX31/MX32 cab during the "incremental programming" procedure.

CV	Denomination	Range	INC-step	De-fault	Description
LEAD - CV #266	Total volume	0 - 255	5	64	See chapter 5.4 "Basic settings independent of powertrain"
#267	Chuff sound frequency with "virtual cam sensor"  also see CV #354 in this table (chuff frequency at speed step 1)	0 - 255	1	70	CV #267 is only active if <b>CV #268 = 0</b> : Chuff beats follow the "virtual cam sensor"; an actual cam sensor is not needed in this case. The default setting "70" results in about 4, 6 or 8 chuffs per wheel revolution, depending on the chuff set selected; because it also depends in large part on the motor and gearbox used, an individual adjustment is necessary in most cases in order to achieve the exact chuff frequency. This is the purpose for CV #267:  The lower the value the higher the chuff frequency and vice versa. The setting should be performed at a low speed (around speed step 10), but not at the lowest speed step 1.
#268	Switching to real cam sensor and trigger count for chuff rate and  Special function for "Simple articulated" steam engines	0 - 63 and Bits 6 & 7	1	0	= 0: "Virtual" cam sensor is active (to be adjusted with CV #267, see above). = 1: real cam sensor is active (connected to switch input 2 of the MX640, see chapter 6); each negative spike results in a chuff beat. = 2, 3, 4 ... real cam sensor, several triggers in sequence (2, 3, 4 ...) result in one chuff beat. = 128 (Bit 7=1 with "virtual" cam sensor): second driver is a bit slower; only meaningful if a second sound sample is available in the sound project. = 192 (Bit 6 and 7 = 1): When no separate sound sample is available for the second driver, the same sample is played back for the second driver albeit a bit slower. Bit 7 = 1 (with <u>real</u> cam sensor, see above for values): Cam sensor for driver 1 on IN3 (as usual), Cam sensor for driver 2 on IN2 (only possible if decoder has 2 inputs).
LEAD - CV #269	Accentuated lead-chuff	0 - 255	10	0	A typical sound signature of a passing steam engine is that one chuff out of a group of 4 or 6 chuffs is louder in volume than the rest; this effect is already part of the chuff set but can be further amplified with the help of CV #269.
#270	PROJECT not functional yet: Longer chuff length at very low speeds	0 - 255	10	?	PROJECT (not yet implemented): The chuff sounds of a real engine are extended when driving at very low speeds due to the mechanical valve control. This effect can be more or less accentuated with CV #270.

CV	Denomination	Range	INC-step	De-fault	Description
#271	Overlapping effect at high speed	0 - 255 (useful up to @ 30)	1	16	The individual steam chuffs of a real engine overlap each other at high speed. Because the frequency of the chuffs increases but won't shorten to the same extend they will eventually blend in to a weakly modulated swoosh. This is not always desired in model railroading because it doesn't sound that attractive, hence CV #271, with which an adjustment is possible to have the chuff beats accentuated at high speed or rather fade away.
LEAD - CV #272	Blow-off duration  also see CV #312 (blow-off key)	0 - 255 = 0 - 25 sec	10	50 = 5 sec	Opening the cylinder valves on a prototype steam engine for the purpose of water drainage is entirely up to the engineer. An automated draining at start-up is more suitable in model railroading; CV #272 defines how long after start-up the blow-off sound should play. Value in CV #272 = time in tenths of a second! Note: If the blow-off sound is also allocated to a function key (as delivered on F4, see CV #312), the automated blow-off sound can be shortened or extended with the relevant function key. Automated blow-off and function key blow-off are inevitably the same (as per selection/allocation). = 0: no blow-off sound playback
#273	Start-up delay during blow-off	0 - 255 = 0 - 25 sec	1	0	Opening the cylinder valves and with it the related blow-off sound on a real steam engine starts most often before the engine even starts to move. This can be imitated with CV #273 by automatically delaying the start of the locomotive. This effect is cancelled when a shunting function with momentum deactivation is being activated (see allocation of F3 or F4 in CV #124!) = 0: no delayed start = 1: Special setting for blow-off via speed regulator; no start-up delay, but setting the speed to the lowest speed step causes the blow-off sound to be played without powering the motor (only with 128 speed steps). = 2: Start-up delay in tenths of a second, Recommendation: no values > 20 (> 2 sec)
#274	Blow-off schedule start-up whistle schedule	0 - 255 = 0 - 25 sec	10	30	Constant opening and closing of the cylinder valves in real shunting operations, that often requires many short trips with associated idle times, is usually omitted. CV #274 causes the blow-off sound to be suppressed if the engine wasn't standing still for the time defined here. Value in CV #274 = time in tenth of a second! The same stop-time is also used for the start-up whistle!

CV	Denomination	Range	INC-step	De-fault	Description
#312	Blow-off key	0 - 19	-	4 = F4	Defines a function key to playback the blow-off sound manually, for shunting with open cylinder valves for example (that is the same sound programmed with CV #300 = 133 for automated playback). = 4: usual blow-off key = 0: no key assigned (use this setting if keys are needed for other purposes).
#354	Steam chuff frequency at speed step 1  also see CV #267 in this table	1 - 255	-	0	CV #354 works only if used together with CV #267! CV #354 compensates for the non-linear speed measurements of the "virtual cam sensor": While the adjustment of CV #267 is done in the vicinity of speed step 10 (slow but not very slow), a correction for speed step 1 can be performed with CV #354 (extremely slow). = 0: no effect = 1...127: more chuff beats in relation to CV #267, = 255...128: less chuff beats.
#154	Several special bits				Bit 1 = 1: DIESEL, ELECTRO: Drive off immediately even if playback of idle sound has not yet finished. Bit 2 = 1: DIESEL, ELECTRO: Wait for idle sound before taking off. Bit 4 = 1: STEAM: Two stage compressor (Z1 for fast refill after coming to a stop, Z2 for slow pressure loss compensation during longer stops). Bit 7 = 1: STEAM: Delay start until playback of start-up whistle has finished. Other bits: OEM Special applications (i.e. Panto control etc.)
#158	Various special bits		-	0	Bit 0 = 1: SPECIAL MX648: Function output FO1 is used for an automatic control wire of an external energy storage. Bit 1 = 1: DIESEL-MECHANICAL: No RPM increase when braking (see CV #364). Bit 2 = 0: RailCom actual speed (kph) feedback in "old" format (for MX31ZL, RailCom ID 4). = 1: RailCom actual speed (kph) feedback in current format (RailCom ID 7). Bit 3 = 1: "Looped" driving sounds will be faded out when switching to a different speed step in order to shorten the sounds. Bit 4 = 1: Steam chuff frequency increases slower at high speed (non-proportional) Bit 5 = 1: Braking (even by one speed step) causes the motor and turbo sounds to decrease by on sound step.

CV	Denomination	Range	INC-step	De-fault	Description
					Bit 6 = 1: Thyristor sound may be louder when braking (even if the volume is supposed to decrease according to CV #357); see CV #357. Bit 7 = 1: SPECIAL MX645: ELECTRIC: Flashes of light (approx. 0.1 sec) on FO7 when switch gear sound is played.
#394	Sample crossfading	0 - 255	-	0	Bit 0 = 1: SPECIAL MX645: ELECTRIC: Flashes of light (approx. 0.1 sec) on FO6 when switch gear sound is played. Bit 4 = 1: Faster acceleration when speed regulator fully opened. Bit 5 = 1: Crossfading of chuff samples

## 5.6 Steam engine → Load and acceleration dependency

The load dependency of the sound is based on the current engine load and the acceleration / deceleration. The result of the "basic" load test run serves as reference for the current motor load, see section 5.3 "The test run for determining the motor's basic load".

NOTE: ZIMO large-scale decoders MX695 and up, and possibly some of the smaller decoders (but not the current MX640 – MX648's) contain a position and acceleration sensor that will improve the function of load dependency dramatically, once it is activated with future software versions.

To set up load dependent sound, follow the **instructions in this order**:

+ Perform "The test run for determining the motor's basic load"; see chapter 5.3

+ Adjust CV's #275 and #276 + Adjust CV #277 + If needed CV #278 and #279

NOTE: The CV's in this chapter affect the sound volume according to load (that is, by how much the volume should increase at higher loads or decrease at lesser loads, all the way down to mute if necessary). A possible exchange of sound samples at load increase or decrease is however a matter of the sound project. There are special exceptions to this rule, though...

NOTE: The **default values** listed for the individual CV's are typical guidelines only, as actual values in operation are determined by the loaded **sound project**; this also means that a HARD RESET with CV #8 = 8 restores the values back to the definition in the sound project.

CV	Denomination	Range	INC-Step	Default	Description
LEAD - CV #275	Chuff sound volume at low speed and no-load	0 - 255	10	60	With this CV the chuff volume can be adjusted for low speed and "basic load" (same conditions as during the "automated recording run"). Here, the engine is driven by about 1/10 of its full speed, adhering to the exact speed is however not important. During this adjustment CV #277 is to be left at "0" (default), so that the setting for "no-load driving" is not influenced by load factors.
#276	Volume at high speed and no-load	0 - 255	10	80	Same procedure as in CV #275 above, but for high speed. CV #276 defines the "basic-load" chuff sound volume at full speed. Set the speed regulator to maximum during this set-up.
#277	Chuff volume changes according to load	0 - 255	10	0 = no reaction	When deviating from the basic load (as determined by the "Automated recording of the motor's "basic load" factor", see above), the chuff beat volume should be increasing (on inclines) or decreasing on declines (even muted). CV #277 defines the degree of change, which must be set to the proper value by trial.
LEAD - CV #278	Load change threshold	0 - 255	10	0	With this CV, a change in volume to small load changes can be suppressed (i.e. in curves) in order to prevent chaotic sound impressions. Suitable settings can only be determined by trial.
#279	Reaction speed to load change	0 - 255	1	0	This CV determines how quick the sound reacts to load changes, whereas the factor is not just time but rather "load-change dependent time" (= the bigger the change the faster the effect). This CV is also used to suppress chaotic sound changes. Suitable settings can only be determined by trial.
LEAD - CV #281	Chuff volume - Acceleration threshold for full load sound	0 - 255 (internal speed steps)	1	1	More powerful and louder chuff sounds should be played back indicating increased power requirements during accelerations, compared to "basic load". The model railroad motor's current consumption however does not change noticeably during accelerations (can't be measured easily), so the effect has to be simulated. As is the case with the prototype, the increased sound should be noticeable before the increase in speed becomes visible, since the latter is a result of the increased steam volume supplied to the pistons. It is therefore practical that the heavy acceleration sound is played back when the speed has increased by just one speed step

					(when no real speed change is noticed), to be able to control the proper sound sequence with the speed regulator. In this fashion, the "engineer" can adjust the sound (by increasing the speed by 1 step) in anticipation of an imminent incline. = 1: Acceleration sound played back (at full volume) if speed has increased by just one speed step. = 2, 3... Acceleration sound played back at full volume only after increasing speed by this number of speed steps; before that: proportional volume.
#282	Duration of acceleration sound	0 - 255 = 0 - 25 sec	10	30 = 3 sec	The acceleration sound should remain for a certain length of time after the speed increased (otherwise each single speed step would be audible, which is unrealistic). Value in CV #282 = time in tenth of a second!
#283	Chuff sound volume during full acceleration	0 - 255	10	255	The volume of steam chuffs at maximum acceleration is set with CV #283 (default: 255 = full volume). If CV #281 = 1 (acceleration threshold set to 1 speed step), the volume defined here is applied with each speed increase, even if it's just 1 step.
LEAD - CV #284	Threshold for deceleration sound	0 - 255 (internal speed steps)	1	1	Steam chuffs should be played back at less volume (or muted) signifying the reduced power requirement during deceleration. The sound reduction logic is analog to a reversed acceleration (per CV #281 to #283). = 1: Reduces sound to a minimum (as per CV #286) when speed is reduced by just 1 step. = 2, 3 ... sound reduced to minimum after lowering speed by this number of steps.
#285	Duration of reduced volume during deceleration	0 - 255 = 0 - 25 sec	10	30 = 3 sec	After the speed has been reduced, the sound should remain quieter for a specific time (analog to the acceleration case). Value in CV #285 = time in tenth of a second!
#286	Volume level during deceleration	0 - 255	10	20	CV #286 is used to define the chuff volume during deceleration (Default: 20 = pretty quiet but not muted). If CV #284 = 1 (deceleration threshold set to 1 speed step), the volume defined here is applied with every reduction in speed (even if decreased by just 1 step).

## 5.7 Diesel and Electric engines →

### Diesel motor sound, Turbocharger sound Thyristor sound, Electric motor and Switchgear sound

Diesel and Electric engines have certain commonalities and are therefore described in the same chapter: Diesel-electric propulsion systems have sound components (sound sequences) from both areas. On the other hand, the separation of "Basic settings" and "Load dependence" (as with the steam engines in the previous chapters) is not practical.

CV	Denomination	Range	INC-step	De-fault	Description
#266	Total volume	0 - 255	5	64	See chapter 5.4 "Basic settings independent of powertrain"
#280	Diesel engine - Load influence	0 - 255	10	0	This CV determines the reaction of the diesel sound to load, acceleration, inclination: Diesel-hydraulic engines – higher and lower rpm's and notches Diesel-electric engines – cruise/idle rpm Diesel-mechanical – shift points. = 0: no influence, motor rpm changes with speed = 1 to 255: minimum to maximum influence. NOTE: It is highly recommended to perform the <b>automated test run</b> with CV #302 = 75 first (see chapter 5.3).
#154	Various special bits		-	0	Bit 1 = 1: DIESEL: Drive off immediately even if idle sound has not finished playback. Bit 2 = 1: DIESEL, ELECTRO: After short stops, wait for idle sound before driving off. Bit 4 = 1, bit 7 = 1: see STEAM.
#158	Various special bits (mostly in connection with functions defined in various other CV's)				Bit 0 = 1: SPECIAL MX648: If function output FO1 is used for automatic control of external energy storage. This was an OEM feature. For more details contact <a href="http://www.zimo.at">www.zimo.at</a> Bit 1 = 1: DIESEL-MECHANICAL: No RPM increase when braking (see CV #364). Bit 2 = 0: RailCom speed (kph) feedback in the "old" format (for MX31ZL, RailCom ID 4). = 1: RailCom speed (kph) feedback in the current format (RailCom ID 7). Bit 3 = 1: "Looped" driving sounds (i.e. idle sound) will be faded out when switching to a different speed step in order to shorten the sounds. Bit 4 = 1: Steam chuff frequency increases slower at high speed (non-proportional) Bit 5 = 1: Braking (even by just one speed step) causes the motor and turbo loader sounds to decrease by on sound step. Bit 6 = 1: Thyristor sound volume may increase when braking (even if the volume is

CV	Denomination	Range	INC-step	De-fault	Description
					supposed to decrease according to CV #357); see CV #357. Bit 7 = 1: SPECIAL MX645: ELECTRIC: Flashes of light (approx. 0.1 sec) on FO7 when switch gear sound is played.
#394	Light-flashes with switch gear sound	0 – 255		0	Bit 0 = 1: SPECIAL MX645: ELECTRIC: Flashes of light (approx. 0.1 sec) on FO6 when switch gear sound is played.
#344	Run time of motor sounds after stops (Cooling fan etc.)	0 - 255 = 0 - 25 sec	-	0	After the engine comes to a stop some accessories are supposed to remain operating (i.e. cooling fans) and automatically stop after the time defined here, provided the engine didn't start up again. = 0: Won't run after stop = 1 ... 255: Runs for another 1 to 25 seconds.
#345	SHIFT key to switch between two sound variations within a sound collection: for different operating modes of a locomotive or between the sounds of a MULTI-SYSTEM engine	1 - 28		0	Defines a function key (F1 – F28) which switches between two sound types that is, between the selected sound in CV #265 and the next one in the list. For example: - Switch between two modes of operation (light train / heavy train) or - Switch between electric and diesel propulsion of a multi-system engine; typical case: Sound project for RhB Gem.
#346	Conditions for switching between collections, as per CV #345	0, 1, 2		0	Bit 0 = 1: Switches between sound collections at stand-still even if sound is ON. Bit 1 = 1: Switching is also possible while driving.
#835	Further switching keys	0 - 32		0	Extension to CV #345. Here the number of consecutive keys can be defined, which then switch to auf Set2, Set3, Set4, .... Then first key is still defined in CV #345.
#347	Switch key for driving and sound performance when driving solo	0 - 28		0	= 0: No key, no switch possible. = 1...28: One of these function keys (F1 – F28) acts as the switch-over key for driving a heavy train or a single locomotive. Parameters are selected with CV #348.
#348	Switch-over parameters for driving solo (with key selected in CV #347)	0 - 31		0	When driving solo (Function key as per CV #347 is ON), the... Bit 0 = 1: Diesel sound should rev up unhindered to maximum rpm (or limited in relation to speed step as per CV #389). Bit 1 = 1: acceleration and deceleration times in CV #3 and 4 should be reduced by the amount defined in CV #390.



CV	Denomination	Range	INC-step	De-fault	Description
					<p>Bit 2 = 1: motor's idle sound should be played-back when driving at low speeds, wherein the highest speed step still playing idle sound is set in CV #391.</p> <p>Bit 3 = 1: deactivate 2nd smoke fan and heating element with this key (diesel loco with two engines only drives with one). Deactivate 2nd smoke fan and heating element on the each time higher output if this key is ON</p> <p>Bit 4 = 1: braking squeal is suppressed with this key</p>
#387	Acceleration influence on diesel sound steps	0 - 255		0	<p>In addition to the selected speed step (as defined in the ZSP flow diagram), actual changes in speed (acceleration, deceleration) should also have an influence on the sound due to the associated increase or decrease in load.</p> <p>= 0: No influence (sound depends on speed step only)                      = 64: experience has shown this to be a practical value                      = 255: maximum acceleration response (highest sound step during acceleration)</p>
#388	Deceleration influence on diesel sound steps	0 - 255		0	<p>Same as CV #387 but used during decelerations.</p> <p>= 0: No influence (sound depends on speed step only)                      = 64: experience has shown this to be a practical value                      = 255: maximum deceleration response</p>
#389	Limited acceleration influence on diesel sound steps	0 - 255		0	<p>This CV determines how far the sound step may deviate during acceleration from the simple speed step dependence (= difference between target speed from the cab and actual speed).</p> <p>= 0: No deviation; motor sounds according to schedule, sound does not depend on acceleration.                      = 1...254: Dependence increases with value.                      = 255: fully dependent on target speed.</p>
#390	Momentum reduction when driving solo (engine only)	0 - 255		0	<p>When switching to solo driving with key defined in CV #347 the momentum reduction is activated (with CV #348, Bit 1):</p> <p>= 0 or 255: No reduction                      = 128: Momentum reduced by half                      = 64: Reduced to ¼                      = 1: virtually cancels all momentum.</p>
#391	Driving with idle sound, when driving solo	0 - 255		0	<p>The diesel motor sound should remain at idle when driving solo (with function key defined in CV #347), until the speed step defined in CV #391 is reached.</p>
#836	Motor Start Sound	Bit 0		0	<p>Bit 0 = 1: Loco shall not start driving before Start Sound is fully played.</p>

CV	Denomination	Range	INC-step	De-fault	Description
#378	Likelihood of switch-gear sparks during acceleration	0 - 255		0	<p>Likelihood for sparks (as per CV #158 Bit 7 for FO7 or #394 for FO6) when accelerating</p> <p>= 0: always                      = 1: very rarely                      = 255: very often (almost always)</p>
#379	Likelihood of switch-gear sparks during deceleration	0 - 255		0	<p>Likelihood for sparks when decelerating (as per CV #158 Bit 7 for FO7 or #394 for FO6)</p> <p>= 0: always                      = 1: very rarely                      = 255: very often (almost always)</p>
#364	Speed drop during upshifts for DIESEL engines with mechanical transmission			0	<p>This special CV applies only to diesel-mechanical engines and defines the typical drop in speed when shifting up.</p> <p>See sound projects (i.e. VT 61)</p>
#365	Upshift rpm for DIESEL engines with mech. transmission			0	<p>This special CV applies only to diesel-mechanical engines and defines the highest rpm before shifting up.</p> <p>See sound projects (i.e. VT 61)</p>
#366	Maximum turbo sound volume for DIESEL engines	0 - 255		48	
#367	Turbo rpm dependency on speed for DIESEL engines	0 - 255		150	<p>Turbo playback frequency depending on engine speed.</p>
#368	Turbo rpm dependency on acceleration for DIESEL engines	0 - 255		100	<p>Playback frequency depends on the difference of set speed to actual speed (= acceleration).</p>
#369	Minimum load for turbo for DIESEL engines	0 - 255		30	<p>Audibility threshold for turbochargers; the load is derived from CV #367 and 368.</p>
#370	Frequency increase of turbo for DIESEL engines	0 - 255		25	<p>Speed of frequency-increase of the turbocharger.</p>
#371	Frequency decrease of turbo for DIESEL engines	0 - 255		15	<p>Speed of frequency-decrease of the turbocharger.</p>
#289	Thyristor control Stepping effect  ELECTRIC engines	0 - 255			<p>The pitch of the thyristor sound of many engines (typical example: Taurus) should not ascend evenly but rather in steps (scale).</p> <p>= 1: no stepping effect, continuous ascend                      &gt; 1: ascending scale according to the corresponding speed step interval.</p>

CV	Denomination	Range	INC-step	De- fault	Description
#290	Thyristor sound, "slow" pitch increase for ELECTRIC engines	0 - 255			Sound pitch for speed defined in CV #292.
#291	Thyristor sound, maximum pitch for ELECTRIC engines	0 - 255			Sound pitch at top speed.
#292	Thyristor low speed for ELECTRIC engines	0 - 255			Speed for sound pitch per CV #290.
#293	Thyristor control, Volume at steady speed for ELECTRIC engines	0 - 255			Thyristor sound volume at steady speed (no acceleration or deceleration in progress).
#294	Thyristor control, Volume during acceleration for ELECTRIC engines	0 - 255			Volume during accelerations
#295	Thyristor control, Volume during deceleration for ELECTRIC engines	0 - 255			Volume during heavier decelerations (braking)
#357	Thyristor control, Lowering the volume at higher speeds for ELECTRIC engines	0 - 255			Internal speed step at which the thyristor sound volume should be reduced. The volume stays at this reduced level while braking.  By changing CV #158 Bit 6 = 1, the volume will be raised while braking, nonetheless.
#358	Thyristor control, Volume reduction curve at higher speeds for ELECTRIC engines	0 - 255			Defines a curve as to how the thyristor sound should be lowered at the speed step defined in CV #357.  = 0: no reduction. = 10: reduced by about 3% per speed step. = 255: aborts the sound when the speed step defined in CV #357 is reached.
	Thyristor control	0 - 255		0	Defines a speed step at which a second thyristor

CV	Denomination	Range	INC-step	De- fault	Description
#362	Switchover threshold for second thyristor sound for ELECTRIC engines				sound for higher speeds is played back; this was introduced for the sound project "ICN" (Roco OEM sound)  = 0: no second thyristor sound.
#393	ZIMO Config. 5	Bit 4		0	=1: Thyristor 2 do not elevate pitch
#394	ZIMO Config. 4	Bit 7		0	=1: Thyristor sound starts playing before start-up
#296	Electric motor sound volume for ELECTRIC engines	0 -255		0	Motor sound volume.
#297	Electric motor, minimum load for ELECTRIC engines	0 -255		0	Internal speed step at which the motor sound becomes audible.  Part of a characteristic curve with CV's #298/299.
#298	Electric motor sound, volume dependent on speed for ELECTRIC engines	0 -255		0	Slope of the characteristic curve for speed dependent volume (curve starts with #297).  See ZSP manual!
#299	Electric motor sound, Sound pitch dependent on speed for ELECTRIC engines	0 -100		0	Slope of the characteristic curve for speed dependent sound frequency (curve starts with #297)  See ZSP manual!
#372	Electric motor sound, Volume dependent on acceleration for ELECTRIC engines	0 – 255		0	= 0: No function = 1...255: minimal to maximum effect
#373	Electric motor sound, Volume dependent on braking for ELECTRIC engines	0 – 255		0	= 0: No function = 1...255: minimal to maximum effect
#350	Switchgear sound, lock-out after depar- ture for ELECTRIC engines.	0 - 255		0	Time in tenths of a second (0 – 25 sec.) during which the switch gear sound should not be played back; useful when the first switching step is already part of the sound sample "idle -> F1".  = 0: Switchgear is heard immediately at departure.

CV	Denomination	Range	INC-step	De-fault	Description
#359	Electric switch gear sound, Switch gear playback duration during speed changes for ELECTRIC engines	0 - 255		30	Time in tenth of a second the switch gear should be heard during speed changes (adjustable from 0 – 25 sec.). Effective only if switch gear sound is part of the sound project.
#360	Electric switch gear sound Switch gear playback duration after coming to a stop for ELECTRIC engines	0 - 255		0	Time in tenth of a second the switch gear should be heard after the engine comes to a full stop (adjustable from 0 – 25 sec.). = 0: no sound after stop.
#361	Switch gear sound Playback delay for ELECTRIC engines	0 – 255		20	During rapid successions in speed changes the switch gear sound would be played back too often. CV #361: Time in tenths of a second (0 – 25 sec.) defines minimum delay between multiple play-backs.
#363	Switch gear sound Dividing the speed into shift steps for ELECTRIC engines	0 - 255		0	Number of shift steps to cover the whole speed range; i.e. if 10 shift steps are programmed, the switch gear sound is played back at internal speed step 25, 50, 75... (a total of 10 times) = 0: synonymous with 5 (5 switch steps over the whole speed range).
#393	ZIMO Config. 5	Bit 2, Bit 3		0	Bit 2=0: Always start with 1st sample of high speed switch gear Bit 2=1: Use one sample after the other, if at the end, start again with 1 <sup>st</sup> sample Bit 3=0: play first and last part when shifting up (middle part only when shifting down) Bit 3=1: skip first and last part also when shifting up (like shifting down)
#380	Manual electric brake key	1 – 28		0	Defines a function key to manually control the sound of a "dynamic" or "electric" brake.
#381	Electric brake - minimum speed	0 – 255		0	The electric brake shall only be heard between the value defend in CV #381...
#382	Electric brake - maximum speed	0 – 255		0	...and the value in CV #382
#383	Electric brake - Pitch	0 – 255		0	= 0: Pitch independent of speed = 1...255: ...depends increasingly on speed.
#384	Electric brake – Deceleration	0 – 255		0	The number of speed steps to be reduced during deceleration before the electric brake sound is played back.

CV	Denomination	Range	INC-step	De-fault	Description
	threshold				
#385	Electric brake – Downhill	0 – 255		0	= 0: no effect at "negative" load = 1 – 255: Sound triggered at "negative" load.
#386	Electric brake – Loops	0 – 15		0	Bit 3 = 0: Sound fades out at the sample end = 1: Sound ends without fading at end Bit 2...0: Increases minimum playback time by 0 ... 7 seconds, to prevent an interruption in break sound between speed steps.
#356	Speedlock key	0 - 28		0	If this key is activated, the speed controller changes the driving sound, not the speed
#837	Script processes	Bit 0-3		0	Bit 0-3 = 1: deactivate Script 1-4

**Coasting and Notching** functions are required for driving situations where the correct engine sound cannot be derived from speed, acceleration and load only. Primarily in diesel locomotives (but not necessarily limited to diesels), the motor's idle sound or a certain specified speed step sound is enforced by keystroke.

This method can be used for "downshifting" (often to neutral) as well as "upshifting" (i.e. elevated idle for heating). Future software versions will expand this function to a fully independent sound effect.

CV	Denomination	Range	De-fault	Description
#374	Coasting-Key (or Notching) (for diesel soundprojects)	0 - 29	0	Function key that activates "Coasting", which forces the motor sound to a specified speed independent of the driving situation. Define the (sound) step in CV #375 (often used for idle sound while coasting). = 0: does NOT mean F0, but rather that NO key is assigned for coasting. = 1 ... 28: One of the function keys F1 ... F28 for "Coasting"
#375	Coasting-Step (or Notching)	0 - 10	0	Motor sound (speed) to be activated with the coasting key (as per CV #374), independent of the driving situation. = 0: Idle sound (typical coasting situations) = 1 ... 10: Sound speed (Diesel engines typically have 5 to 10 notches, which can be activated with the coasting key.
#398	Automatic Coasting	0 – 255	0	The number of speed steps the train's speed has to be reduced within 0.5 seconds in order for the automatic coasting effect to set the motor sound to idle (without assigning a coasting key above). The motor sound will not return to idle if the speed is reduced at a slower rate.

It is especially expedient for diesel engines to be able to **raise the sound step manually** with a function key.

CV	Denomination	Range	De- fault	Description
#339	Key for raising diesel sound step	0 - 28	0	Function key that raises the diesel sound to the minimum speed defined with CV #340. See below if more keys for further speed raises are required.
#340	Diesel sound step and possibly more keys.	0 - 10	0	The minimum diesel step the sound is to be raised to with the function key defined with CV #339. This CV can be extended (to include more function keys (in succession) by applying the formula: Minimum speed step + (16 * (Number of keys -1))

### 5.8 Random and Switch Input sounds

CV	Denomination	Range	Default	Description
#315	Random generator Z1 Minimum interval	0 - 255 = 0 - 255 sec	1	The random generator generates internal pulses in irregular intervals that are used to playback a sound file assigned to the random generator. CV #315 defines the shortest possible interval between two consecutive pulses. Sound samples are assigned to the random generator Z1 with the help of the CV #300 = 101 procedure, see above! By default, the compressor is assigned to Z1. Special note to random generator Z1: The random generator Z1 is optimized for the compressor (which should be played back shortly after the train has stopped); therefore the default assignment should be retained or at the most be used for a different compressor. CV #315 also determines the proper time the compressor is started after coming to a stop!
#316	Random generator Z1 Maximum interval	0 - 255 = 0 - 255 sec	60	CV #316 defines the maximum time interval between two consecutive pulses of the random generator Z1 (that is most often the start of the compressor after coming to a stop); the actually occurring pulses between the values in CV #315 and #316 are equally distributed.
#317	Random generator Z1 Playback length	0 - 255 = 0 - 255 sec	5	The sound sample assigned to the random generator Z1 (most often the compressor) is played back for the timespan defined in CV #317. = 0: Sample plays once (in the defined duration)
#318 #319 #320	As above but for sound generator Z2	0 - 255 0 - 255 0 - 255	20 80 5	By default, Z2 is assigned for coal shoveling at stand-still.
#321 #322 #323	As above but for sound generator Z3	0 - 255 0 - 255 0 - 255	30 90 3	By default, Z3 is assigned for the injector at stand-still.
#324	As above but for	0 - 255		As delivered, this random generator is not assigned to any

#325 #326	sound generator Z4	0 - 255 0 - 255		sound.
#327 #328 #329	As above but for sound generator Z5	0 - 255 0 - 255 0 - 255		As delivered, this random generator is not assigned to any sound.
#330 #331 #332	As above but for sound generator Z6	0 - 255 0 - 255 0 - 255		As delivered, this random generator is not assigned to any sound.
#333 #334 #335	As above but for sound generator Z7	0 - 255 0 - 255 0 - 255		As delivered, this random generator is not assigned to any sound.
#336 #337 #338	As above but for sound generator Z8	0 - 255 0 - 255 0 - 255		As delivered, this random generator is not assigned to any sound.
#341	Switch input 1 Playback duration	0 - 255 = 0 - 255 sec	0	The sound sample allocated to switch input 1 is played back for the duration defined with this CV. = 0: Play back once (duration as recorded)
#342	Switch input 2 Playback duration	0 - 255 = 0 - 255 sec	0	The sound sample allocated to switch input 2 is played back for the duration defined with this CV. = 0: Play back once (duration as recorded)
#343	Switch input 3 (if not used for the cam sensor) Playback time	0 - 255 = 0 - 255 sec	0	The sound sample allocated to switch input 3 is played back for the duration defined with this CV. = 0: Play back once (duration as recorded)

## 6 Installation and Wiring

### General information:

There has to be enough **free space inside the vehicle** so that the decoder can be mounted without exerting mechanical stress. Pay particular attention that no pressure is applied to the decoder when the loco housing is being reinstalled and the wires can't get caught by movable parts.

All direct connections that are present in the original wiring configuration between the power pick-ups (wheels and wipers) and the motor **must be isolated**; otherwise the motor end stage may get damaged at power-up.

The same goes for the **headlights and other additional accessories**, which must be completely isolated.

**Do noise suppression components on a locomotive motor have a negative effect on motor regulation?**

Yes, sometimes ...

Explanation: Motors of model railroad locomotives are often equipped with choke coils and capacitors, which are supposed to suppress or filter out electric noise caused by sparks arcing across the motor's brushes (causing poor TV reception etc.).

Such components impair the motor regulation. Compared to others, ZIMO decoders manage quite well and there is hardly a difference in performance with or without those components in place. However, in recent years larger choke coils are being installed in many locomotives than was the case earlier – and these can noticeably compromise drivability.

The potentially “harmful” choke coils are often recognizable by their shape, as they look like a resistor with color bands (in contrast to a wire wound ferrite bar). That doesn't mean though that these choke coils have a negative effect in all cases.

**Lessons learned and accompanying measures...**

ROCO, BRAWA, HORNBY – so far present no problems, no action necessary.

FLEISCHMANN H0 with “Round motors” – choke coils are no problem; capacitors should be removed if necessary, especially the ones between frame and motor (may destroy the decoder if left in place)!

Newer Bühler motors – no problems so far.

TRIX H0 – choke coil between track and decoder plug should be removed!

MINITRIX, FLEISCHMANN PICCOLO – very inconsistent; removing of capacitors is often advantageous; choke coils on the other hand presented no problems so far.

Indications of a harmful effect of such components, besides a general unsatisfactory motor control (jerking...), are:

- weak BEMF compensation: as confirmation, set the decoder for testing purposes to low frequency – CV #9 = 200 – and see whether the control compensation becomes stronger. If that's the case, the choke coils are most likely to blame.

- if a difference in compensation is noticeable between 20 kHz and 40 kHz (selectable in CV #112, Bit 5), it is very possible that the choke coils or capacitors are the cause.

**Remedy:** Bypass choke coils (or replace with wire strap)! Remove capacitors! Capacitors are less likely to interfere with motor regulations.

**Locomotives with 6 or 8 pin NMRA interface . . .**

. . . are easy to retrofit with the MX...R, MX...F, MX...N (e.g. MX630R or MX620F) etc. They come with the appropriate 8 (R) or 6 (F, N) pin connector. There is usually enough room provided in such locos. Removing the dummy plug from the loco automatically interrupts all damaging connections and the decoder can be plugged in instead.

In some cases it is necessary to hardwire some decoder leads besides just plugging in the plug. An example of this is the MX630R that has more outputs available than the standard 8-pin plug has pins. For hard-wiring of decoder leads use the explanations below.

**Hard-wiring a locomotive...**

**... with a DC motor and headlights:**

This represents the **most common wiring diagram** for HO installations. All other diagrams that follow are modified or extended versions of this one.

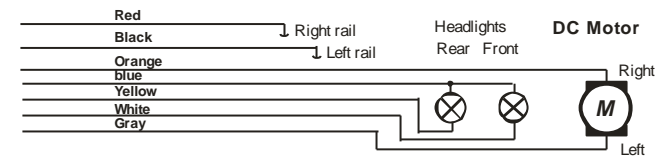

Headlights connected as shown on this diagram are directional and switched on/off by the F0 key. With the appropriate use of "function mapping" - CV's #33, 34, 35... – it is also possible to control the headlights independently with F0 and F1.

PLEASE NOTE: Body mounted light bulbs that are hard to isolate can be left as is. The body acts as the power supply to the bulb. The blue lead from the decoder must not be connected to the bulbs in such circumstances. The white and yellow leads are connected to the other side of the bulbs. The brightness of the headlights will be reduced with such an application

**... with an AC motor:**

Two additional 1N4007 diodes (or equivalent – min 1A) are required as shown in the diagram below when installing a decoder in a loco equipped with an AC motor. They can be obtained at your local electronic store or from ZIMO.

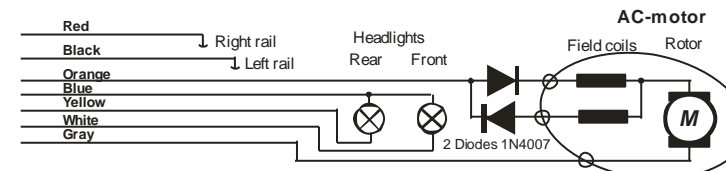

Most locomotives with AC motors get the power supplied by a third rail, which is of no significance as far as the motor hook-up is concerned. The above schematic is therefore valid for AC locomotives running on two or three rail track (instead of “right rail” and “left rail” think “outside rails” and “center rail”).

Note: many locomotive manufacturers supply field magnets that can be used in place of the motor's field coil. Using a field magnet turns an AC motor into a DC motor, which is connected as such (see above) and can also utilize the decoders BEMF feature (BEMF does not work with AC motors).

### Additional hook-up for cab lighting controlled with F0 key:

This is no longer of much use today; it is a remainder from a time when decoders only had two function outputs, which were used for the headlights and the cab light. Cab lights connected this way can be switched with the F0 key but in contrast to the headlights were non-directional.

This is however a general schematic that can be used in cases where something is to be operated by several different function outputs, but the same outputs used independent of each other. There are 2 diodes required (type 1N4007 or equivalent) available from ZIMO or any electronic parts supply store.

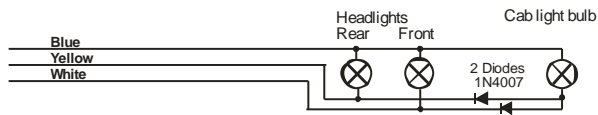

### Connecting function outputs FO1, FO2, FO3, FO4...:

Depending on decoder type, function outputs FO1 and higher are available on wires, solder pads or part of a connector (i.e. the MX620 offers FO1 and FO2 on solder pads, the MX630 and MX632 on wires and further outputs on solder pads) and can be connected in the same fashion as headlights.

For mapping the outputs to function keys, see chapter 5; the function outputs FO1 and FO2 are mapped by default with function keys F1 and F2.

Also see note on MX632 below!

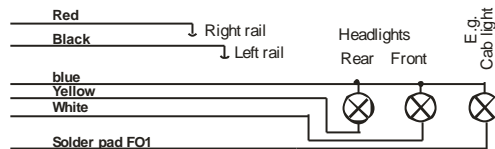

### Using logic level outputs:

ZIMO decoders also have so called logic level outputs in addition to the normal function outputs, to which current consuming devices may not be connected directly. Use a ZIMO M4000A amplifier or similar transistor switching device, when connecting logic level outputs with a load.

Some logic level outputs are used alternatively for the "SUSI-CLOCK" and SUSI-DATA" connections and can be switched to logic level outputs when setting CV #124 Bit 7 = 1 (if SUSI is not required). Furthermore, the same pins can be used for servo control (activated with CV's #181 & 182).

**NOTE on MX632:** The logic level outputs FO5 and FO6 of the MX632 are identical in their function as the amplified outputs FO5 and FO6 (not FO7 and FO8 as was first announced erroneously); however, if "SUSI" (CV #124, Bit 7) or servo control (CV's #181, 182) is active, neither the amplified outputs FO5/FO6 nor the logic level outputs FO5/FO6 will be functional!!

The brown lead of an amplifier module M4000Z is connected with the relevant logic level output solder pad of the decoder.

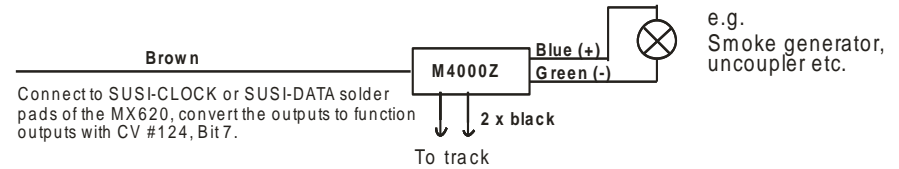

### Connecting DIETZ sound modules without "SUSI" / "virtual cam sensor"

Consult the Dietz instruction manual regarding the installation and connection of their sound modules to a ZIMO decoder.

For a good acoustic impression of steam engines, it is important that the chuffs are synchronized to wheel revolutions. Therefore a cam sensor should be installed and connected to the sound module (reed switch, optical or hall-effect sensor), which sends exactly 2 or 4 pulses to the module (depending on loco type).

If no cam sensor can be installed or an installation proves too difficult, many sound modules can also generate their own chuff rate based on speed information (e.g. coming through the SUSI interface from the decoder). The result is often poor with a chuff rate that is too fast at low speeds (the SUSI protocol is not precise enough in that respect).

To improve this situation, ZIMO decoders come with a built-in "virtual cam sensor". The function output FO4 is used for this purpose, converted to a "virtual cam sensor" function with the help of CV #133 and connected with the cam sensor input of the sound module (e.g. Dietz, reed switch input); this in addition to SUSI or other connections.

The virtual cam sensor is of course not capable of synchronizing chuff rates to wheel positions but rather to wheel speed, which is of little difference to the viewer.

The chuff rate of the "virtual cam sensor" can be adjusted to wheel revolutions with CV #267 and CV #354; consult the CV table in ZIMO sound chapter.

### Connecting of DIETZ or other sound modules with "SUSI":

The SUSI interface developed by Dietz is an NMRA standard and defines the connection between sound modules and loco decoders, provided the sound module is also equipped with such an interface.

Due to space restrictions on small decoders, the SUSI interface composed of 4 conductors (2 data, ground and power) is not built as a plug-in connector but instead uses 4 solder pads (see decoder drawings in the chapter "Technical specifications" in this manual).

Speed and load information (uphill, downhill, startup etc.), as well as programming values for the sound module CV's (#890...) are sent via the SUSI data lines (CLOCK and DATA) from the decoder to the sound module.

**Accessing SUSI CV's in the SUSI module:** These CV's are in the 890 range, according to the standard (NMRA DCC Draft RP), which is not accessible with many DCC systems (ZIMO cabs MX2 and MX21 were also limited to 255 - until mid-2004). For this reason, ZIMO decoders allow access to these CV's with numbers in the 190's!

**Connecting an electric (un)coupler (System "Krois"):**

In order to prevent damage to the delicate core of an uncoupler from continuous power, appropriate adjustments can be made with special CV's for one or several function outputs.

First, write the value "48" to the special effect CV that is assigned to the same output an uncoupler is connected to (e.g. CV #127 for output #1, CV #128 for output #2 etc.)

Next define a limit for the uncoupler's activation time in CV #115 (see CV-table):

With the "Krois uncouplers", it is recommended to use a value of "60", "70" or "80" for CV #115; this means that the pull-in voltage (full track voltage) is limited to 2, 3 or 4 seconds. A reduced "hold" voltage is not required for Krois, that's why the ones digit is left at 0. Other uncouplers may need a reduced hold voltage though, like the ones from ROCO for example.

Regarding the "automated train disengagement" and/or "automatic coupler unloading" see CV #116 in the chapter "Addressing and programming", section "Configuration of Electric Uncouplers".

**MX622R, MX623R, MX630R... with NMRA 8-pin interface (NEM 652):**

The "R" designated decoders come with an 8-pin plug mounted to the end of its wires, which fits in to the socket of a DCC ready loco. Remove the dummy connector from the socket and plug the decoder in its place, that's all.

All the necessary connections to power, motor and headlights are established with this interface. Other outputs have to be hard wired.

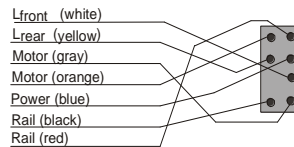

**MX621F, MX623F, MX630F... with NMRA 6-pin interface (NEM 651):**

The "F" designated decoders come with a 6-pin plug mounted to the end of its wires, which fits into the socket of a DCC ready loco.

The brightness of the headlight is reduced since the blue wire (common supply) is not part of this interface. The light bulbs get their power directly from the power pick up.

The blue wire is still available at the decoder and can be used if required, but when used on aforementioned bulbs that get power directly from the track (usually through the frame) they must first be isolated from the power source!

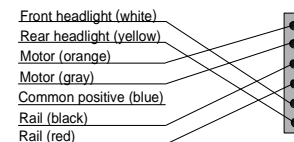

**MX621N, MX622N - plugs directly into the 6-pin interface (NEM 651):**

Many N, HOe, HOm as well as some HO engines have this socket installed with the required minimum space of 14 x 9 mm to accept the decoder.

**ATTENTION:**

Plug the decoder into the socket with the pins down and the **microprocessor on top** (visible)!

**MX620**  
Micro processor side shown  
(connector pins are soldered to other side !)



**MX631D, MX632D, MX632VD, MX632WD, MX640D, MX642D, MX644D  
MX631C, MX632C, MX640C, MX642C, MX644C - with 21-pin interface:**

These decoders have a 21-pin female plug on the circuit board (no wires), which allows the decoder to be plugged directly in to the 21-pin male receptacle of locomotives equipped with such interfaces. There are actually 22 pins present but one of those pins (#11, top right) serves as a key to prevent wrong installations. The 21-pin interface is standardized by the NMRA-DCC PR 9.1.1., just like the 6 and 8-pin interfaces (see schematic below left).

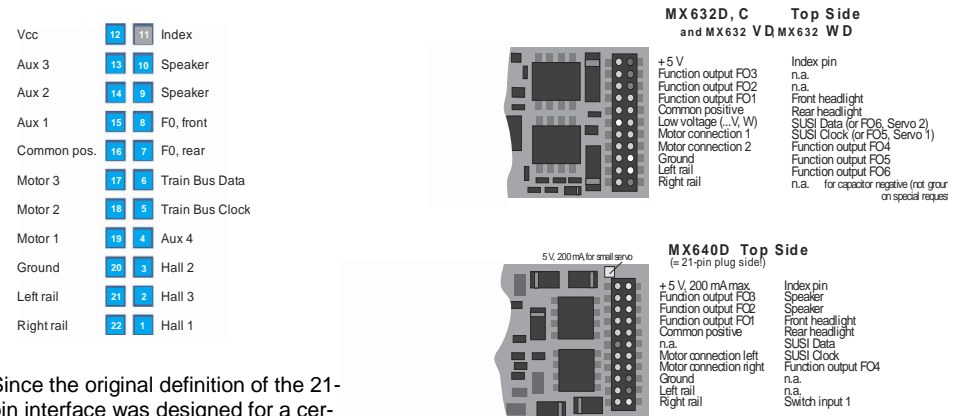

Since the original definition of the 21-pin interface was designed for a certain motor configuration (C-Sinus), some of the pins are not used for the intended purpose (Hall effect sensor, motor 3) with "normal" applications and are being used for other functions instead.

The "C-Type" decoders MX631C, MX632C, MX640C, MX642C differ from the "D-type" by the function outputs FO3 and FO4: logic level outputs for "C", normal outputs for "D". "C-Type" for Märklin, Trix and LS models.

Therefore, depending on decoder configuration, there are slightly different pin configurations on the 21-pin socket connector. These additional outputs can only be used if the vehicle is specially adapted to it. For example, the function outputs FO4 - FO6 and the low voltage supply of the MX632D are also available at other solder pads on the decoder; see the connection diagrams in the chapter "Technical Information".

**21-pin decoder plugged into loco board, i.e. TRIX**

Plugged in right side up, pins of the loco board penetrate through the decoder board into the socket.



**21-pin decoder plugged into loco board, i.e. BRAWA**

Decoder is plugged in upside down !



Decoders with the 21-pin plug can be installed in two ways; the decoder board below the connector is perforated so that the decoder can be plugged in from the top or bottom end, depending on the locomotive. The index pin 11 prevents a wrong installation by not allowing the decoder to be pushed all the way down.

**MX623P12, MX630P16, MX633P22, MX645P16 and MX645P22...**

**- Decoder with PluX-Connector:**

In contrast to the 21-pin interface (see above), the PluX connection has the male connector mounted on the decoder and the female on the loco board. "PluX" is available with 8, 12, 16 and 22 pin connectors and also use one of the pins for indexing.

The PluX system is defined by the NMRA 9.1.1 and the NEM, including the maximum dimensions for standardized decoders.

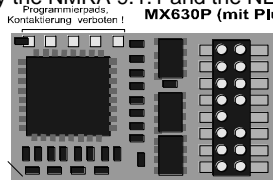
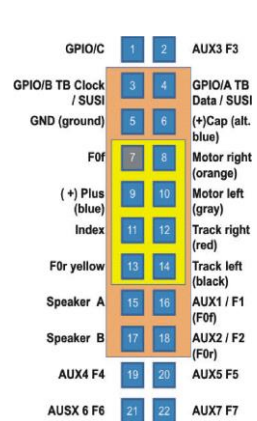

SUSI, Servo's (2, 1) oder FA6, FA5  
 Gem. Pluspol (+) MASSE  
 Motor rechts Stirnl. vome (= Lvor)  
 Motor links Gem. Pluspol (+)  
 Schiene rechts --- (Index)  
 Schiene links Stirnl. hint (= Lrück)  
 Funktions-Ausgänge FA1 FA3  
 Funktions-Ausgänge FA2 FA4

The MX630P16 comes with a 16-pin male plug (15 usable pins, 1 index pin) and can be plugged into engines with 16-pin sockets but also in engines with 22-pin sockets (see drawing at left: brown area = 16-pin).

In 8-pin (yellow) and 12-pin equipped locomotives it depends on the available space whether the 16-pin version can be used.

The MX630P, which is NOT a sound decoder, uses the two pins originally defined for speaker outputs for the additional outputs FO3 and FO4 instead. This will not damage speakers that may be installed in the locomotive and connected to those pins.

**MX623 Top View, pin-out (PluX-12)**

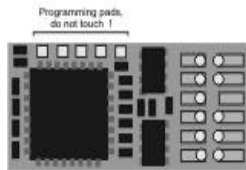

Motor right  
 Motor left  
 Right rail  
 Left rail  
 Function outputs  
 Function outputs  
 Lfor  
 Gem. Pluspol (+)  
 --- (Index)  
 Lrev  
 F03, F04 are logic level outputs!  
 F01 F03  
 F02 F04

The MX623P12 (which is narrower than the MX630!) has the 12-pin "PluX" connector. It does not have the upper 4 connections as the MX630 and therefore does not have SUSI or GROUND connections on the plug.

**MX633P22 Top View (with PluX22)**

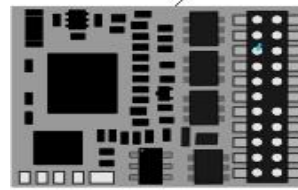

Function output FO3  
 SUSI Data (Servo 2)  
 Capacitor positive  
 Motor right  
 Motor left  
 Right rail  
 Left rail  
 Function output FO1  
 Function output FO2  
 Function output FO5  
 Function output FO7  
 Switch input  
 SUSI Clock (Servo 1)  
 GROUND  
 Front headlight (= Lfor)  
 Common positive (+)  
 --- (Index)  
 Rear headlight (= Lrev)  
 Speaker  
 Speaker  
 FO4  
 Fo6

Programming pads, do not touch!

The MX633P22 has a "complete" PluX connector with 9 function outputs.

The sound decoders MX643 was and the MX645 is available with either 16 or 22-pin "PluX" connector. Also see chapter 2 ("Technical Information").

**MX645P16 Top View (with PluX16)**

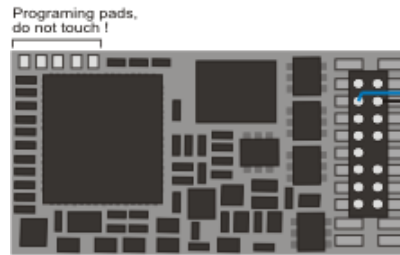

Capacitor as power back-up. (is normally mounted on loco circuit board and connected via plug)  
 The SUSI outputs can alternatively be used as servo outputs;  
 Cap. Pos. + >220 uF 20 V Cap negative (same as GROUND)  
 SUSI Data (Servo 2)  
 Cap. pos.  
 Motor right  
 Motor left  
 Right rail  
 Left rail  
 Function-Output FO1  
 Function-Output FO2  
 Function-Output FO8  
 SUSI Clock (Servo 1)  
 Ground  
 Front headlight  
 Common positive (+)  
 --- (Index)  
 Rear headlight  
 Speaker  
 Speaker

**MX645P22 Top View (with PluX22)**

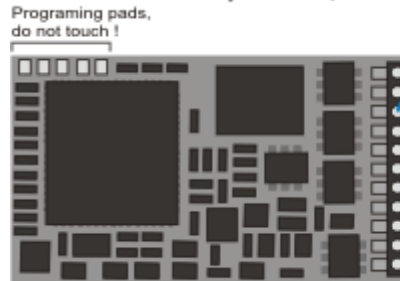

The SUSI outputs can alternatively be used as servo outputs;  
 Function-Output FO3  
 SUSI Data (Servo 2)  
 Capacitor positive  
 Motor right  
 Motor left  
 Right rail  
 Left rail  
 Function-Outputs FO1  
 Function-Outputs FO2  
 Function-Outputs FO5  
 Function-Outputs FO7  
 Function-Output FO8  
 Switch input  
 SUSI Clock (Servo 1)  
 GROUND  
 Front headlight  
 Common positive (+)  
 --- (Index)  
 Rear headlight  
 Speaker  
 Speaker  
 FO4  
 FO6



**Connecting servo and SmartServo motors:**

2 servo control outputs are available on the MX620, MX630, MX632 and MX640 decoders for the control of commercially available servo motors or **SmartServo RC-1** (Manufactured by TOKO Corp. Japan). The corresponding solder pads or pins on the 21-pin or PluX connector can be used alternatively for SUSI or as logic level outputs or as demonstrated here for servo control.

The SUSI and logic level functions are not available if the servo mode is activated (through CV's #181 and 182, see below); this is also true for the function outputs FO5 and FO6 on the MX632.

The models **MX632W** and **MX632WD** also contain a **5V power supply** to power servos directly; the 5V supply on the **MX640** is limited to 200mA.

For other decoder types, the 5V must be supplied by an external voltage regulator such as the readily available LM7805; connected as shown in the drawing.

The outputs can be activated for servo control duty with CV's #181 and CV #182 (the value in each must be different than 0).

With the help of CV #181 and #182, the servo functions can be mapped to various function keys (plus direction) and selected for control with either one or two function keys.

CV's #161 to #169 define the servos end positions and rotating speed, see CV table.

CV #161 also defines the appropriate servo protocol. "Normal" for most servos is positive pulses (which is also the default setting); furthermore a selection can be made whether the servo is powered only while it is being moved or remains powered at all times. The latter should only be used if the servo position could change by outside mechanical influences.

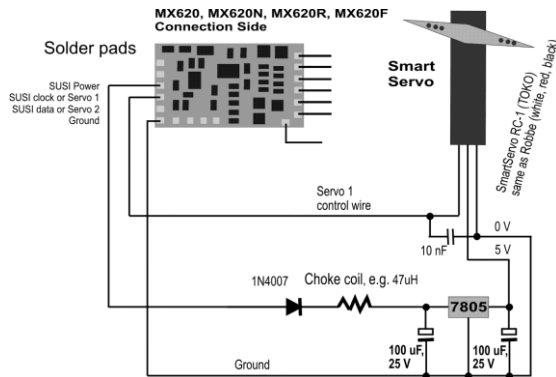
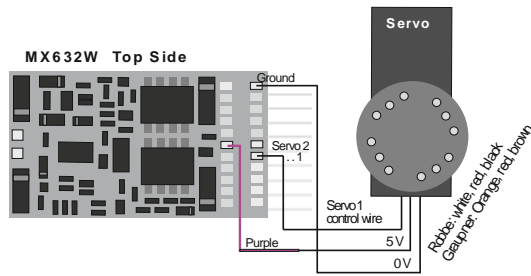
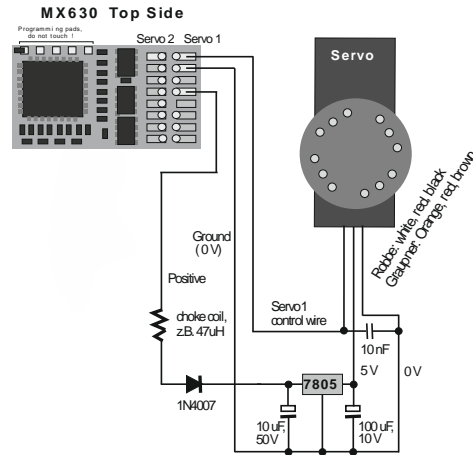

**Connecting MX640 and MX642 to servo and SmartServo motors:**

Two servo connections are provided on the MX640 for commercially available servos and SmartServo RC-1 (Manufacturer: TOKI Corp., Japan). These are normally the **SUSI outputs** but can also be used as **servo outputs** instead. The connections are in the form of either solder pads or part of the 21-pin socket, depending on the decoder type. Each output can be connected directly with a servo control wire.

"Energy-saving" servos (max. 200mA) can be powered directly by the MX640!

For servos with higher energy consumptions, the 5V operating voltage must be supplied by an external voltage regulator such as the readily available LM7805 as shown in the drawing.

The outputs can be activated for servo control duty with CV's #181 and CV #182 (the value in each must be different than 0). With the help of CV #181 and #182, the servo functions can be mapped to various function keys (and direction) and selected for control with either one or two function keys.

CV's #161 to #169 define the servos end positions and rotating speed, see CV table.

The appropriate servo protocol can be selected with CV #161. "Normal" for most servos is positive pulses (which is also the default setting); furthermore a selection can be made whether the servo is powered only while it is being moved or remains powered at all times. The latter should only be used if the servo position could change by outside mechanical influences.

For the **SmartServo**: Bit 1 of CV #161 must always be set, that is CV #161 = 2!

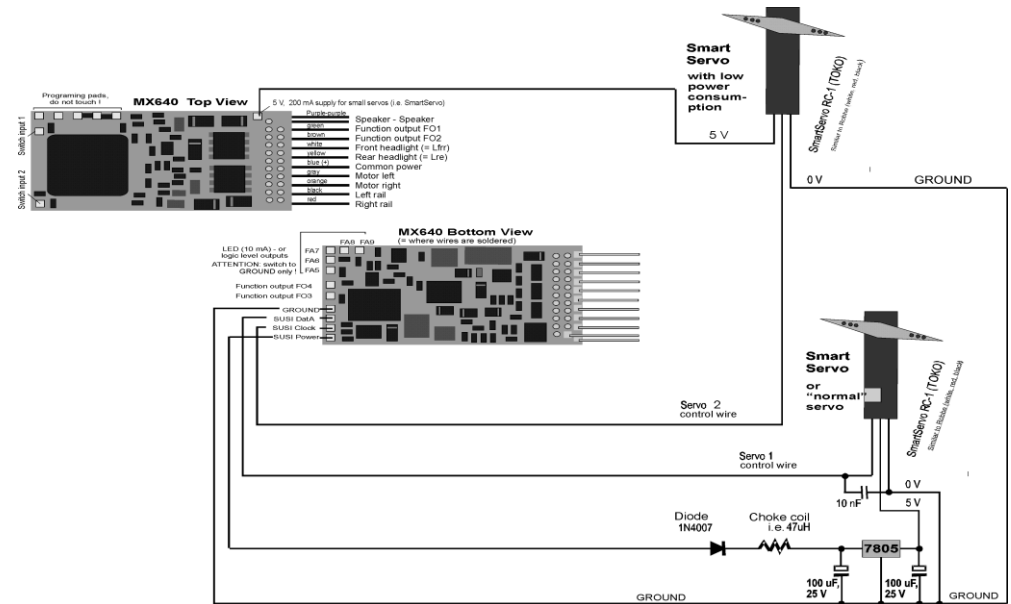

**MX640... – Complete Schematic including Sound Connections**

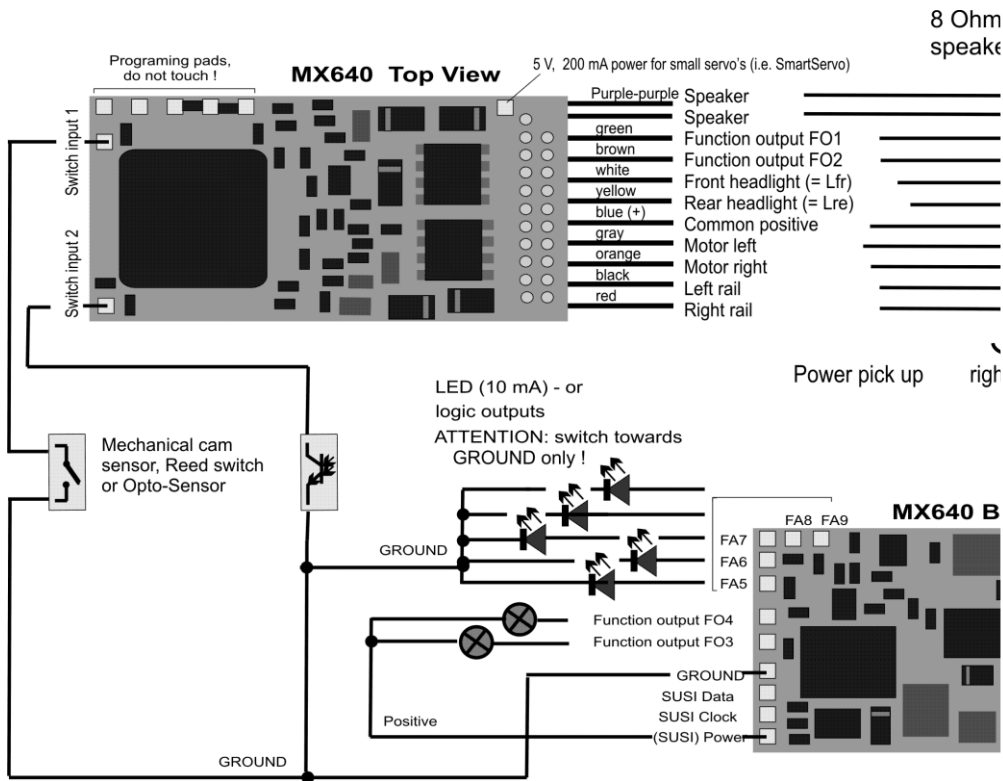

**MX642, MX644, MX645 ...**

More recent sound decoder versions are to be wired the same way, except that

- GROUND, switch input and common power are on solder pads on the top right side or from the blue wire (common power), and
- only 2 LED outputs (MX642) or none at all, which when available are accessible at the SUSI solder pads on the decoders top-side.

Also see the decoder schematics on the front pages of this manual.

**Connecting speaker, cam sensor:**

In order to operate the MX640 as a sound decoder, the following items must/may be connected:

- mandatory – **SPEAKER** – Any 8-ohm speaker or two 4 Ohm speakers connected in series can be used. Speaker with higher impedance are also allowed but will result in reduced volume.

An additional tweeter (also 8 Ohms or higher) can be connected, if desired; the connection should be made via a bipolar capacitor (10 uF bipolar for 2 kHz frequency).

- optional – **CAM SENSOR** – Normally, ZIMO decoders are programmed for the “virtual cam sensor”, which can be fine-tuned with CV #267 and CV #354. If a real cam sensor is to be used, the settings of CV #268 must be changed to 1 or 2 depending on whether each pulse or every second pulse should trigger a chuff beat.

Mechanical contacts, Reed switches, optical switches and Hall Effect switches are suitable as cam sensors.

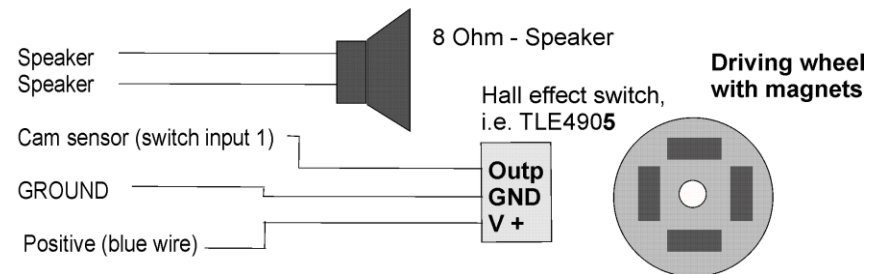
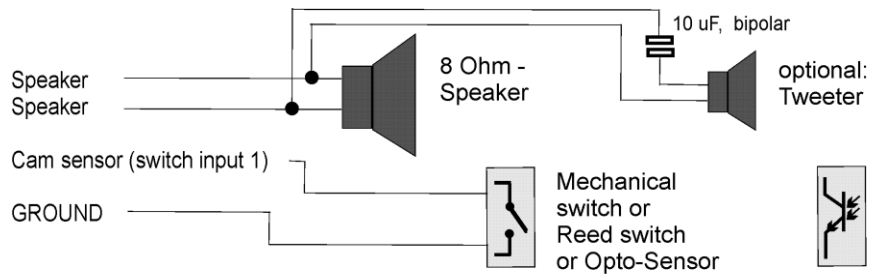
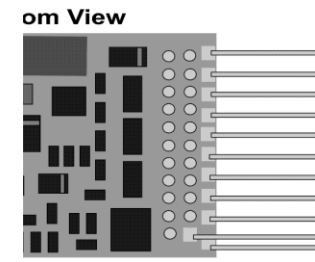

**Connecting an external energy source (capacitor) for uninterrupted driving on dead track sections:**

Energy storage devices connected to the decoder have many benefits; even very small capacitors as of 100uF have positive effects, larger ones even more so:

- Prevents stalling and flickering lights on dirty track sections or frogs, especially in conjunction with the ZIMO "smart stopping" feature (requires at least 1000µF to be effective)
- Lowers decoder operating temperature especially with low-impedance motors (minimum of 100uF is required)
- when RailCom is used:  
Eliminates the energy loss created by the "RailCom gap", reduces motor noise caused by RailCom and improves the quality (= legibility) of the RailCom signal (minimum of µF is required)

The connections to the decoder and the required voltage strength of the capacitor are determined by the decoder type, track voltage and its intended use. Distinction is made between three cases, which are described below.

**"PluX-like" decoders WITH direct capacitor hook-up:**

"PluX-like" are all decoders belonging to families containing PluX types, even the hard-wired versions

Capacitors to be connected must be rated (regardless of track voltage) at: **16 V**  
(The charging voltage is limited by the decoder to 16 V).

Among the decoders described in this manual, only the decoders of the **MX633** family (non-sound) and the sound decoder **MX645** including their predecessors (i.e. MX643) and successor types have the necessary components on board for a **direct connection**, without the need of additional external components.

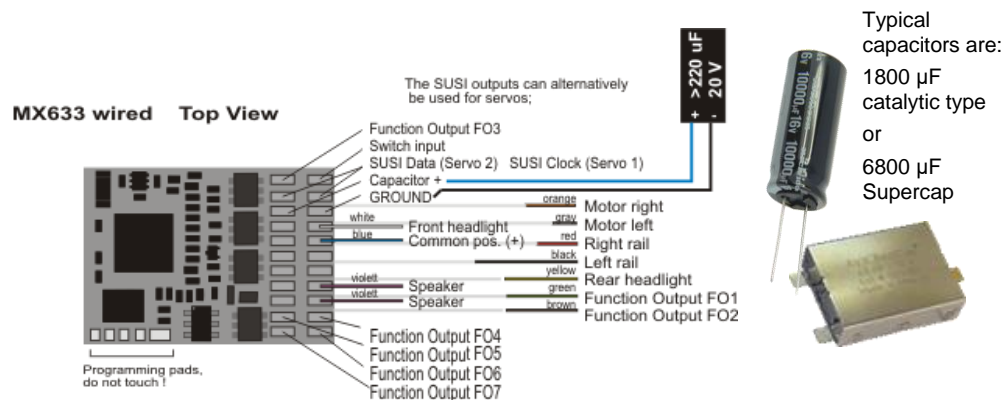

The largest capacitor allowed in general is **5000 µF**, but slightly larger capacities are allowed (i.e. the **Supercap68** from the ZIMO offerings with **6800 µF**).

The MX633 can accept even larger capacitors such as the gold cap modules with 140000 µF (7 gold caps in series).

The decoder boxes are shipped with a small capacitor (i.e. 680 µF) as an entry into the energy storage technology. Larger capacitors connected in series are recommended and are easily available even from ZIMO.

**"MTC-like" decoders WITH direct capacitor hook-up:**

"MTC-like" are all decoder belonging to families containing MTC types, even the hard-wired versions

Capacitors to be connected must be rated at: "generally" **25 V**  
(In contrast to the "PluX-like" decoders, charging voltage is not limited here)  
If ensured that the track voltage never exceeds 16 V or 20 V: 16 V or 20 V respectively  
ATTENTION: if AC analog operation shall be possible (with high voltage pulse for direction change): **35 V**

This group includes the decoder families **MX632**, **MX634** (non-sound) and **MX644** (sound) and their predecessor (e.g., MX631, MX642) and successor types; the capacitor is connected without any additional components to the appropriate connectors. Two wires (blue, gray) are available in case of hard-wired decoders and on the MTC versions the connections are established through the MTC plug (or the solder pads on the bottom). The following example shows the connection to a non-sound decoder MX634 and MX644 sound decoder (hard-wired or with connector):

The solder pad assignments of the MX634 and MX644 are the same!

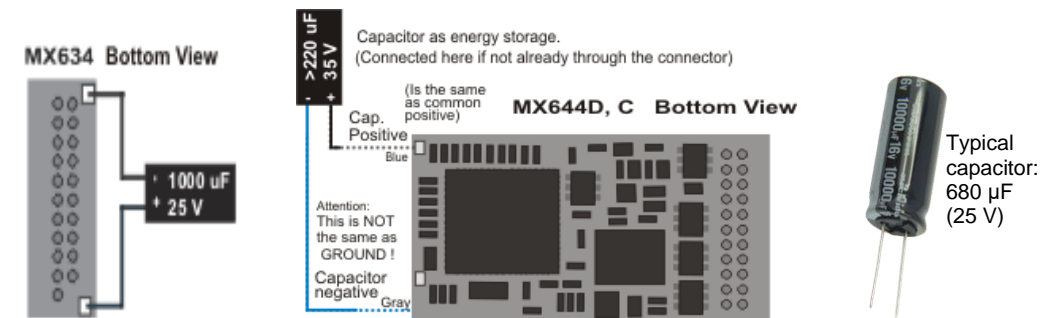

The permitted capacity of the connected capacitor is generally limited to **5000 µF**; the 6800 µF Supercap (see "PluX-like" decoders) is NOT allowed because their dielectric strength of 15 V is too low (not so much because of its capacity). EXCEPTION: if it can be guaranteed that the track voltage NEVER exceeds 16 V, the use of Supercaps would be possible!

NOTE: chapter 7 describes the use of decoder adapter boards such as the ADAMTC or ADAMKL with which any size capacitor could be used (including the ZIMO gold cap modules with 140000 µF), even with a dielectric strength of only 16V.

**Important ZIMO feature in connection with the use of external energy storage: Smart stop management on "dead" track sections:**

If power to the decoder is interrupted due to dirty rails, wheels or insulated frogs, the decoder automatically keeps the engine going even if the engine is supposed to come to a stop. The engine is allowed to come to a full stop as soon as power to the decoder is restored. With the engine stopped the decoder tests again for track power and if needed moves the engine another very short distance until track power again is restored (provided of course there is enough power available from the energy storage capacitor).

**Decoders *WITHOUT* direct capacitor hook-up:**

Whether "PLUX-like", "MTC-like" or other interface layouts

Capacitors to be connected must be rated at: "generally" **25 V**  
 (according to tack voltage)  
 If track voltage can never exceed 16 V or 20 V: 16 V or 20 V respectively  
 ATTENTION: if AC analog operation is enabled (with high voltage pulse for direction change): 35 V

The group WITHOUT direct capacitor hook-up includes miniature and medium sized decoder such as the **MX621, MX622, MX623, MX630** (non-sound) and **MX646, MX648, MX658** (Sound) as well as their predecessors and successors.

A simple connection of a capacitor between the decoder's ground and common positive is NOT advisable with these decoders, since it could lead to undesired side effects: the unlimited inrush current while charging may trigger the short circuit protection of the command station; plus it may hamper or prevent software updates, sound uploads, programming in service mode (on the programming track) and the ZIMO loco number identification. Nevertheless, capacitors can be connected but only with external components added by the user.

The connection of such an energy storage circuit (in contrast to decoders with dedicated wires or pins for "direct energy storage circuitry", see above) is always between the decoder's GROUND and the "positive" or "common positive" (= the blue wire).

The easiest and a very **space efficient** solution is the connection of a simple resistor between the capacitor and the decoder (i.e. 33 Ohm). This prevents any large currents flowing in/out of the capacitor and thereby suppresses the above mentioned undesirable side effects (even if the inrush current is still too high, when compared to official specifications). In the following schematics, the miniature decoder MX621, MX622 and the miniature sound decoder serve as examples:

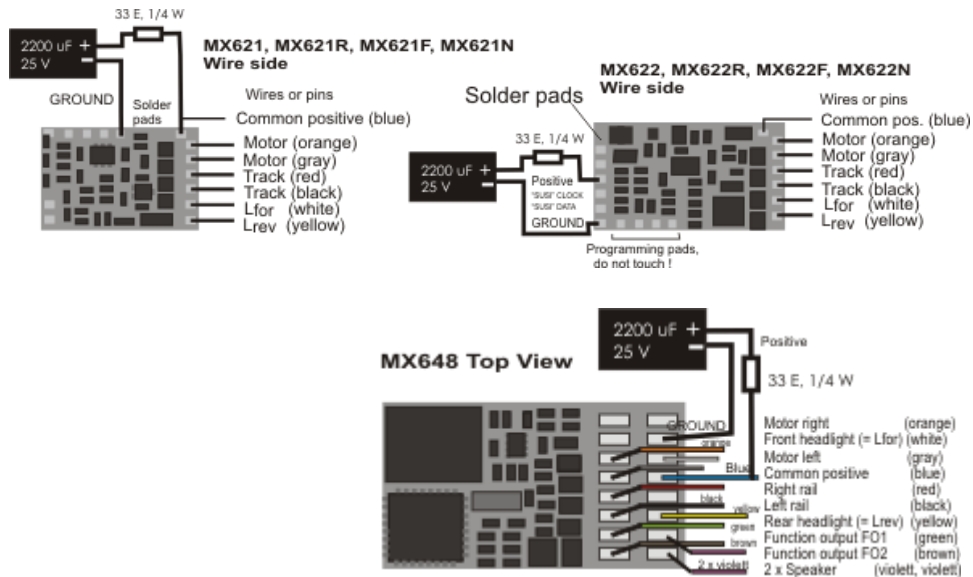

**WARNING - ONLY FOR SMALL CURRENT:** The resistance of course also reduces the effectiveness of the energy storage device, because the voltage drop also limits the available discharge current for the decoder to about 200 mA (as well as losing about 6V in the process). This circuit can still be very helpful for small engines (especially in N-scale but also TT or HO engines with efficient motors and LED lighting instead of bulbs).

If **more space** is available, an advanced circuit should be used: the capacitor is charged via a resistor (e.g. 68 Ohm) to reduce the "inrush current" while the diode (e.g. 1N4007N) bridges the resistor during discharge, so that the discharge current can flow unhindered to the decoder. The choke coil ensures that the software update, sound upload, programming in "service mode" (programming track) and the ZIMO loco number identification functions reliably despite the full discharge current from the capacitor. The 3K3 resistor causes an intentional self-discharge, so that a residual voltage is not retained over a long period of time, which would keep the processor's memory alive and thus lead to strange effects. In the following schematics, the decoder MX623 and MX630 serve as examples:

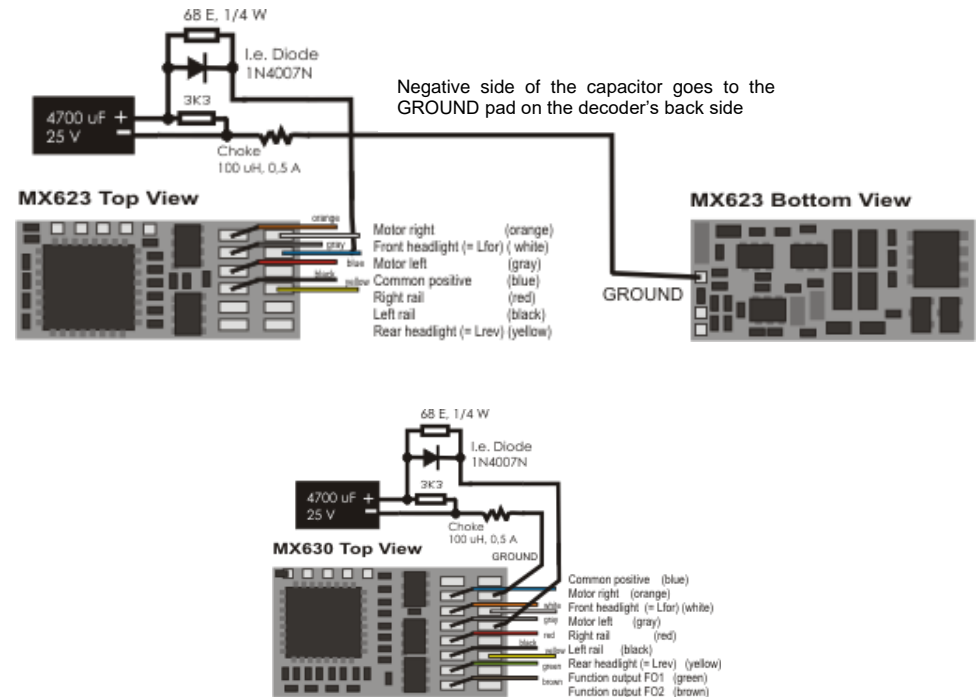

**Energy storage components in the ZIMO product range**

ZIMO offers a range of assortments (electrolytic capacitors, tantalum and gold caps) as well as storage modules; see the product/price list or Info on [www.zimo.at](http://www.zimo.at) (decoder, energy storage). There is a capacitor or storage module available for all decoder types and sizes.

Energy storage solutions for ZIMO decoders can be based on **electrolytic capacitors** or **tantalum capacitors** as well as **Super caps** and **Gold caps**.



Supercap68

Electrolytic

Gold cap module with 7 gold caps (7 x 1F in series = 140000 F - 17.5)

**MX632V, MX632W, MX632VD, MX632WD - the special MX632 design with built-in low voltage supply**

These decoders contain an efficient **1.5V** or **5V regulator**, which can be directly connected to low voltage bulbs. The low voltage is available at the purple wire and is used for the corresponding loads in place of the “common positive” (blue) wire.

MX632V and MX632VD (1.5V) decoders facilitate the installation considerably especially in high quality brass models (which are often equipped with such bulbs), because it eliminates the installation of an external voltage regulator (that often requires some sort of heat sink).

MX632W and MX632WD (5V) decoders are primarily meant for large scale engines (i.e. LGB) that are often equipped with 5V bulbs. The 5V supply can also be used to drive servos, which eliminates the need for an external voltage regulator.

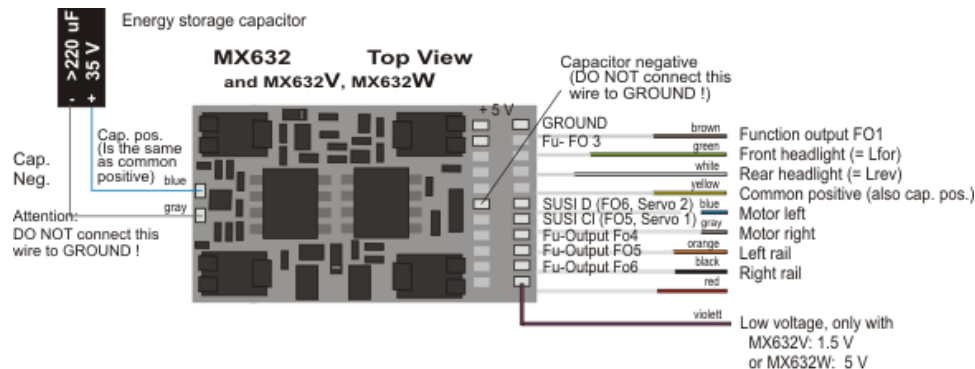

**MX640, MX642, MX643, MX644, MX645, MX646 - connecting smoke generators to steam and diesel engines:**

**With a “Seuthe” 18V smoke generator as example:**

In addition to a simple ON/OFF function with a function output of your choice, these decoders are also capable to adapt the smoke **volume** to the **load** (almost no smoke at **standstill**, little smoke at **cruising**, heavy smoke at **start-up** etc.).

This requires the smoke generator to be connected to one of the function outputs **FO1** to **FO6** and the selected output must be programmed with the associated special effect CV (with CV #127 for FO1, CV #128 fir FO2 etc.) for the desired effect; in this case for load dependent smoke for steam engines (effect code “72”) or load dependent smoke for diesels (effect code “80”).

**EXAMPLE:** - Steam engine, smoke generator connected to function output FO5: CV #131 = 72.

The selected function output is further defined by CV #137, 138 and 139 (“Definition of smoke generator characteristic”). These CV’s must be programmed with appropriate values otherwise the smoke generator will not produce any smoke.

**EXAMPLE:** - Typical characteristic for a track voltage set around 20V with above smoke generator:

CV #137 = 70...90: little smoke at standstill.

CV #138 = 200: The smoke generator output is increased to about 80% of its maximum capacity beginning with speed step 1 (lowest speed step), which produces relatively heavy smoke.

CV #139 = 255: The smoke generator is driven to its maximum, which results in thick smoke under heavy acceleration.

**Synchronized steam chuffs or typical diesel smoke with fan-controlled smoke generators:**

ZIMO sound decoder (MX645...), with the help of a smoke generator **with built-in fan**, can produce steam puffs synchronized with the sound chuffs or load dependent diesel smoke (i.e. diesel engine smoke at start-up, controlled by the sound project) without additional electronic components.

The heating element of the smoke generator is connected – as in the example above with the “Seuthe” generator – to **FO1...FO6** and configured with the appropriate CV for the desired effect (i.e. “72” for steam or “80” for diesel).

The fan is connected to the function output **FO4** (or **FO2** in exceptional cases such as the **MX646**); the other wire of the fan motor often requires a low voltage (check with the manufacturer) and is therefore connected to an external voltage regulator or – if the fan motor requires 5V – to the 5V supply of the decoder, if such an output is available.

The CV’s must be programmed as follows:

CV #137, #138, #139 = 60, 90, 120 respectively: (IMPORTANT) if the heating element cannot operate at full track voltage; the voltage at the function output must be limited, which is done with suitable values in CV #137, 138 and 139.

CV #133 = 1: (IMPORTANT) this configures output FO4 as a fan output.

CV #353 = ...i.e. 10: shuts the smoke generator off automatically to prevent overheating. In this example (10) after 250 seconds.

CV #351, #352 = .... Only for diesel engines when special effect code “80” is selected in the applicable CV for FO1...FO6. This defines the fan speed (voltage) for start-up (default: maximum smoke) and cruising (default: medium smoke); see CV table.

CV #355 = .... For steam and diesel engines. Defines the fan speed (voltage) at standstill (usually for very little smoke output).

**MX631C, MX632C, MX634C, MX642C MX644C... for C-Sinus (Softdrive)**

The **MX631C, MX632C, MX634C, MX640C, MX642C** and **MX644C** (C-type) decoders are made especially for Märklin and Trix engines that are equipped with a **C-Sinus motors** and come with a 21-pin interface. The decoder also **supplies** the necessary **5V** for the C-Sinus board (which "normal" decoders can't!).

These C-type decoders can also be used for **Märklin, Trix and Märklin compatible** engines that come with other types of motors but cannot process normal outputs on function output FO3 and FO4, but require logic level outputs instead.

The C-type decoders differ from the normal 21-pin plug decoders (MX631D, MX632D, MX634D, MX640D, MX642D, MX644D) in the use of output pins FO3 and FO4. The D-type has normal (amplified) outputs on these pins while the C-type has logic level outputs. These logic level outputs supply the needed 5V for activating the C-Sinus or Softdrive loco board or for the power pick-up switch found in many vehicles.

The MX631C, MX632C, MX634C (or MX640C, MX642C, MX644C sound decoder) is plugged into the pins of the loco board with the top side of the decoder pointing up, whereby the pins are being pushed through the decoder board in order to make contact with the decoder socket. The position is given by the loco board and prevents a wrong installation by the missing pin 11 (on the loco board) and missing hole in the same location on the decoder board.

The picture below shows a sample layout; the loco board may however vary from case to case.

Loco board with 21-pin plug and MX632C plugged in      Flat ribbon cable to C-Sinus motor

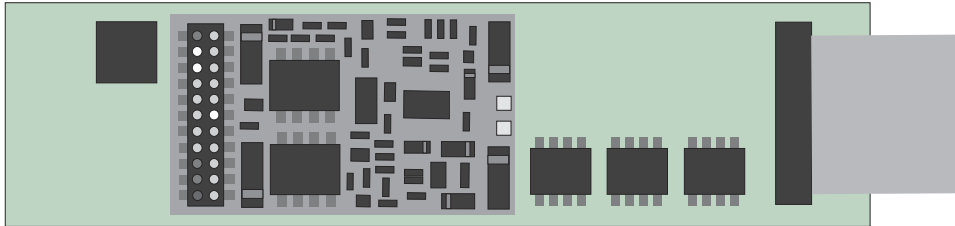

Before plugging in the decoder, check the C-Sinus board whether it contains **0-Ohm resistors**; see **CAUTION on the next page!!**

All C-type decoders are "normal" decoders for "normal" motors except for the function outputs FO3 and FO4. They can be switched to **C-Sinus motor control** by programming **CV #145**: specifically, **CV #145 = 10** if the engine originally came with a Märklin/Trix decoder or **CV #145 = 12** if the original decoder was from ESU (recognizable by a blue circuit board). Depending on the C-Sinus motor design a setting of = **11** or = **13** may deliver a better result (try it!).

With the help of **CV #145** the decoder can also be configured for some special versions, which becomes necessary due to different decoder interface layouts on the part of Märklin/Trix, see CV table!

Locomotives equipped with C-Sinus-capable ZIMO decoders can be operated in the **NMRA-DCC-data format** as well as the **MOTOROLA protocol**, but not in analog mode (DC)!

No motor regulation, known as BEMF, is possible when the decoder operates in the C-Sinus mode, since the motor tries to keep the target speed precisely in all situations. The relevant configuration variables such as CV #9, #56 and #58 have no effect!

**CAUTION:**

Unfortunately, Märklin/Trix has played a "dirty trick" (although probably not on purpose): Beginning with a specific model or past a certain date, the protective resistors on the loco board have been omitted, or more precisely, instead of the 100kΩ resistors useless **0 Ohm resistors** are being installed. The resulting voltage is too high for the loco board which will not only destroy the board but can also damage the decoder, unless the decoder has been switched to the C-Sinus mode with CV #145 = 10 or 12, before being plugged in.

**But even if CV #145 = 10 or 12 is set first, there is no guarantee that the loco board with 0 Ohm resistors will survive in the long run** (even if there is no obvious problem at the moment)!

Background information: Although the 21-pin interface in Märklin and Trix locomotives is virtually identical to the standardized NMRA-DCC 21-pin interface, Märklin keeps modifying it whenever the need arises (several versions, "misapplication" of function outputs for motor activation and now the mentioned electrical input changes); their own brand decoder is the only one that is being taken into account through all this. The installation of other brand decoders is obviously not desired...

**CORRECTIVE MEASURE: C-type decoders must not be installed if zero-ohm resistors** (markings "000") are found on the loco board in place of actual protective resistors (markings "104"). It is imperative that these are being replaced with **100kΩ resistors** ("104") before installing the decoder.

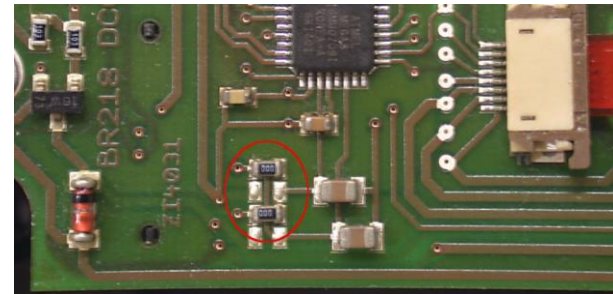

Above is a picture showing a loco board with the useless ("000") resistors; in such cases it is not allowed to plug in a MX631C, MX632C... decoder!

Due to the many different C-Sinus boards that have been produced it is impossible for us to provide precise information about the location of these resistors on each board. Because the resistors may be mounted in different locations on the board in your engine, we would suggest that you find them by following the traces. First study the picture below. The blue and pink arrows are pointing out the traces that connect these resistors with the processor. Note the processor pins those tracers are leading to.

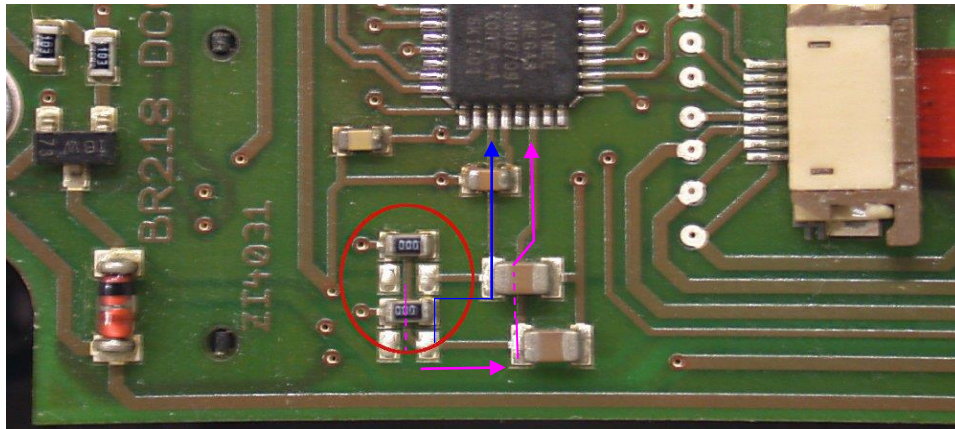

Next find the same pins on the processor of your board and follow those traces carefully. They should lead to resistors marked as either "104" or as "000" (see below). If they are "104" proceed with the decoder installation. If they are marked as "000" they have to be replaced before the decoder is installed.

This picture shows a different Märklin C-Sinus board and how the resistors in question can be located by following the traces back from the controller pins.

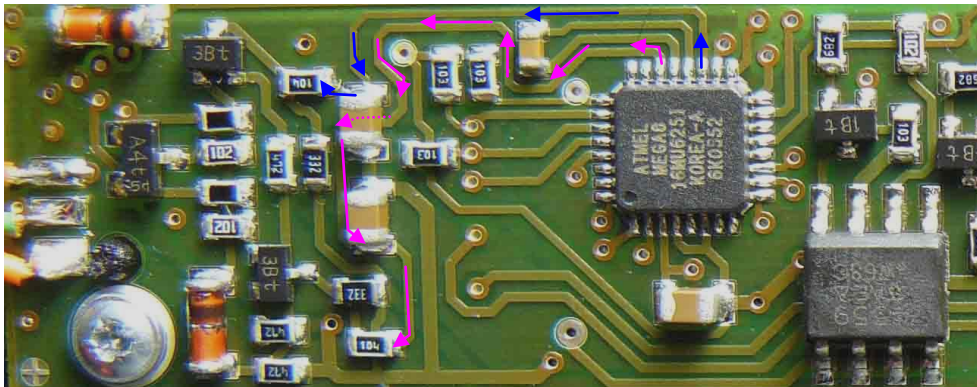

### CAUTION II – Disclaimer of Liability

Märklin/Trix obviously is not concerned about compatibility of their locomotives with third-party products. The interfaces are being changed often and without notice. ZIMO cannot guarantee that the information given in this manual regarding connection and programming/operating procedures are correct in all instances and cannot assume liability for damages to loco boards and/or decoders as a result of such circumstances.

## 7 ADAPTER boards, Energy storage

ZIMO decoders hardly need any extensions when it comes to the number of function outputs because they already offer up to 10 functions (MX633 and MX645!), plus 2 additional servo outputs. The adapter boards nevertheless offer other often requested features:

- **large solder pads** at function outputs facilitate the wiring of the locomotive. Multiple common terminals are available (i.e. positive supply and possibly the 1.5V or 5V low voltage), which are often required by several devices.
- an additional rectifier on each adapter board increases the **overall performance** of the decoder (when plugged into the board) by about 50% to a total current of **1.8 A**, which makes H0 decoders also suitable for "smaller large-scale vehicles" (requires less space than "real" large-scale decoders).
- depending on the version, they come with a voltage regulator for **low function output voltage** of **1.5V** (ADA...15) or **5.0V** (ADA...50). The 5.0V supply can also be used to power servos; all ZIMO decoders have 2 servo control outputs available at the SUSI terminals.

These adapter boards come in several basic versions:

**ADAPLU:** Adapter board for PluX22 decoder, especially for the **MX645P22** (sound) and **MX633P22** (non-sound).

*Not suitable for MX630P16 or MX648P16 (due to missing capacitor charging circuit)*

ATTENTION: Use of gold cap modules on these boards is NOT permissible, only electrolytic capacitors with up to 7'000uF at 16V... unless the decoder itself allows gold caps (i.e. MX633P22).

Options: ADAPLU15 and ADAPLU50 with low voltage function output of 1.5V or 5.0V respectively.

**ADAMTC:** Adapter board for MTC-21 decoder, especially for the **MX644C** (sound) and **MX634C** (non-sound).

Use of gold cap modules (GOLM...) for all decoders is possible!

Options: ADAMTC15 and ADAMTC50 with low voltage function output of 1.5V or 5.0V respectively.

**ADAMKL:** Adapter board for MTC-21 decoder with screw terminals, otherwise the same as ADAMTC, especially for the **MX644C** (sound) and **MX634C** (non-sound).

Use of gold cap modules (GOLM...) for all decoders is possible!

Options: ADAMTC15 and ADAMTC50 with low voltage function output of 1.5V or 5.0V respectively.

**ADAPUS:** Adapter board for PluX22 decoder, especially for American made models (Athearn, Kato...), connections are arranged the same as on the original boards.

ATTENTION: Use of gold cap modules on these boards is NOT possible, only electrolytic capacitors with up to 5'000uF at 16V... unless the decoder itself allows gold caps (i.e. MX633P22).

Options: ADAPUS15 and ADAPUS50 with low voltage function output of 1.5V or 5.0V respectively.

**ADAPLU – Adapter boards for PluX22 decoder:**

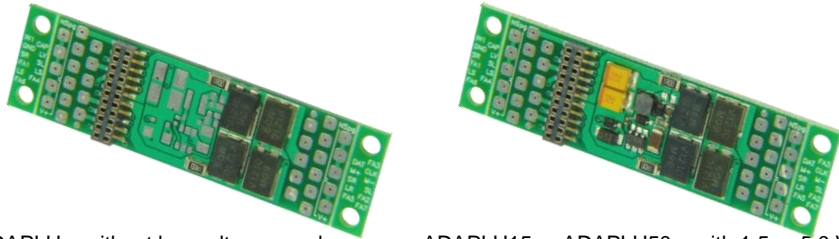

ADAPLU – without low-voltage supply      ADAPLU15 or ADAPLU50 – with 1.5 or 5.0 V supply

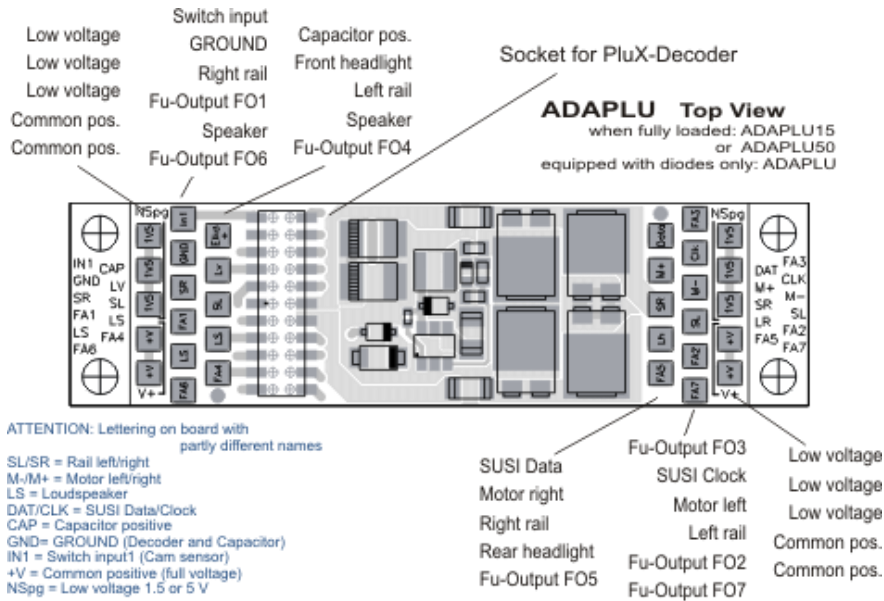

**ADAPLU with MX645P22 plugged in**

← results in a sound decoder with  
**1.8 A** motor (total current)  
**9** function outputs  
**2** logic-level outputs (for servos, SUSI)  
**3 Watt** audio, 4 – 8 Ohm, 32 Mbit  
 with direct connection for 16 V catalytic capacitors or super caps to 6800 µF  
 Dimensions: **45 x 15 x 8 mm**

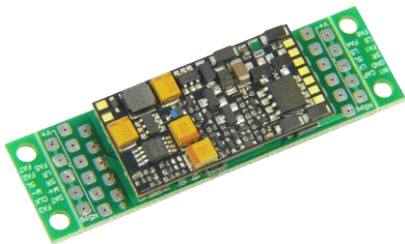

**ADAMTC – Adapter boards for MTC-21 decoder:**

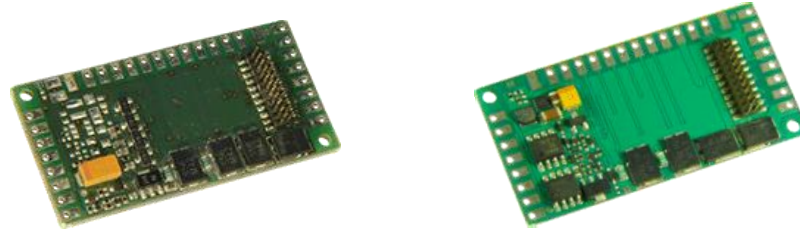

ADAMTC – without low-voltage supply      ADAMTC15 or ADAMTC50 – with 1.5 or 5.0 V supply

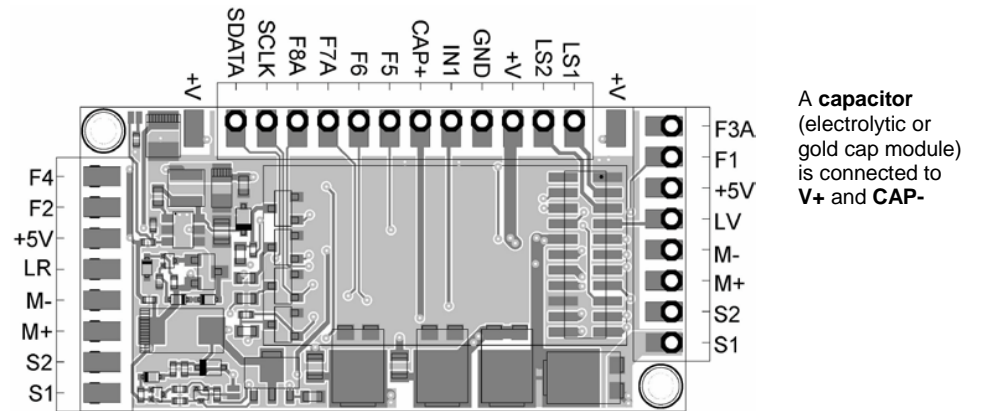

A capacitor (electrolytic or gold cap module) is connected to **V+** and **CAP-**

**ADAMTC50 with MX644C plugged in**

← results in a sound decoder with  
**1.8 A** motor (total current)  
**8** function outputs  
**2** logic-level outputs (servos, SUSI)–  
**5V** low voltage output  
**3 Watt** audio, 4 – 8 Ohm, 32 Mbit  
 with direct connection for 16 V catalytic capacitors or gold caps module with 7 gold caps  
 Dimensions: **44 x 26.5 x 6 mm**





**ADAMKL – Adapter boards with screw terminals for MTC-21 decoder:**

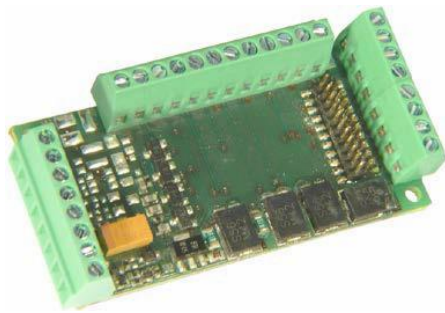

ADAMKL – without low-voltage supply

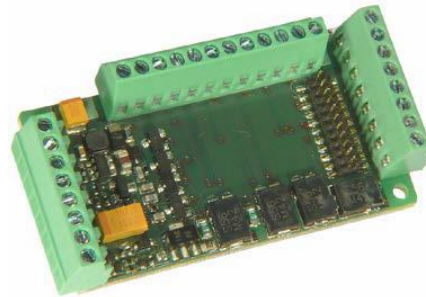

ADAMKL15 or ADAMKL50 – with 1.5 or 5.0 V supply

Connection layout is the same as with the solder pad version.

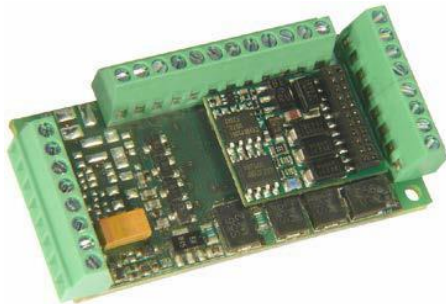

**ADAMKL with MX634C plugged in**

results in a sound decoder with  
**1.8 A** motor (total current)  
**8** function outputs  
**2** logic-level outputs (for servos, SUSI)  
 with direct connection for 16 V catalytic capacitors  
 or gold caps module with 7 gold caps  
 Dimensions: **44 x 26.5 x 12 mm**

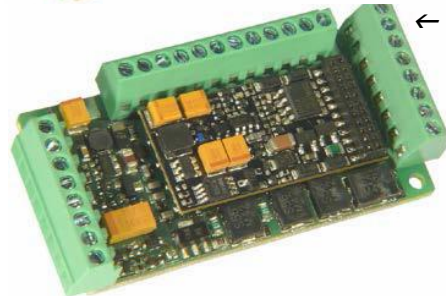

**ADAMKL15 with MX644C plugged in**

results in a sound decoder with  
**1.8 A** motor (total current)  
**8** function outputs  
**2** logic-level outputs (for servos, SUSI)  
**1,5V** low voltage output  
**3 Watt** audio, 4 – 8 Ohm, 32 Mbit  
 with direct connection for 16 V catalytic capacitors  
 or super caps to 6800 µF  
 Dimensions: **44 x 26.5 x 12 mm**

*Typical application for this decoder/board combination: O-scale!*

**IMPORTANT NOTES to the use of adapter boards:**

**POSSIBLE PROBLEMS during SOFTWARE UPDATE and SOUND UPLOAD**

when using **adapter boards with low-voltage supply**  
 (ADAPLU15, ADAPLU50, ADAMTC15, ADAMTC50, ADAMKL15, ADAMKL50)

Software updates and sound uploads (via a MXULF, MXDECUP, MX31ZL...) may fail due to the voltage regulator on the adapter board!

Remedy: The decoder must be removed from the board and connected directly to the update module.

**ATTENTION: Connecting large smoke generators (USA-Trains or similar) is NOT possible!**

While the adapter board does increase the overall performance of the decoder by means of additional rectifiers, it does NOT increase the current limit of the decoder's function outputs.

**NOTES on connecting Servos to ADAPLU50 (version with 5V – low-voltage supply), power supplied between low voltage "NSPG" (= 5V) and "GND" (ground), and controlled by the servo control line on one of the terminals "SUSI Clock "or" SUSI Data ".**

The commercially available servo drives behave very differently. While many types can be operated without any problems, others exhibit various problems and in many cases also depends on whether the command station creates a "RailCom gap". Jerking at standstill, or running several times between stops after power-on and when operating the servo may be observed.

A REMEDY in such cases is usually possible by adding capacitors - 1) A 16V 2200 µF (or larger) capacitor connected to the usual energy storage circuit (i.e. between "CAP Plus" and "GND"), and

2) A 220 uF, 6.3 V (may also need higher or lower than 220 µF, trial and error!) capacitor in the supply lines of the servos (i.e. between "POS" and "GND").

**ADAPUS – “American” adapter boards for PluX22 decoder:**

A new adapter board ADAPUS was created specifically for use in **US models (Athearn, Kato etc.)**. It is based on the original decoder board as found in many U.S. models, but unlike these, it allows access to all 10 function outputs of the plugged-in **ZIMO Sound decoder MX645P22**. Here too, the versions ADAPUS15 and ADAPUS50 equipped with a voltage regulator **offer low function output volt-ages of 1.5V or 5V** respectively.

Note: The low voltage can also be raised from 1.5V to 5V by bridging the solder pads shown on the right (this may come in handy when the wrong board is at hand...). Many micro bulbs require 1.5V but servos usually 5V. For LED's the 5V, with appropriate resistors, is also the right choice.

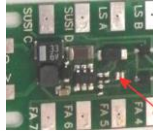

Pictures:  
ADAPUS15 with 1.5V low voltage, 71 x 18 x 4mm

ADAPUS15 with ZIMO decoder MX645P22, 71 x 18 x 7.8mm

The adaptor board also has the characteristic “fingers” that accept the original plastic caps for attaching the connecting wires (if that is even desired).

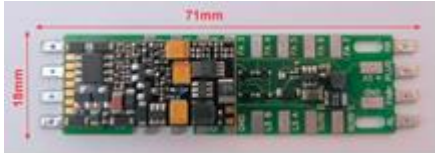

Comparison of an original loco board (left) and the ADAPUS (right)

**The function output FO8:** is not present at the standardized PluX interface but is nevertheless available at the ZIMO MX645 decoder, exactly at the same location where the pin (“Index”) on a “normal” MX645P22 is missing (a PluX standard to prevent incorrect insertion). The decoder can also be ordered with this pin intact at special request...which makes the output FO8 accessible on the adapter board (this decoder version though can no longer be plugged into a PluX interface, where the hole for this pin is plugged – it is strictly speaking no longer a “PluX” decoder...).

Of course other PluX decoders, besides the 22-pin, such as the **12 or 16-pin PluX decoder** can also be plugged into the adapter board. Attention must be paid though to the correct location within the 22-pin socket when using 12 or 16 pin PluX decoders. The picture on the right shows a MX630P16 (PluX-16) as an example:

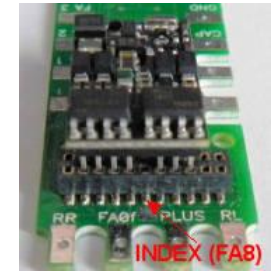

Note: Unlike the MX633P22 or the MX645P22 that come with an energy storage circuit, the MX630P16 does NOT! In these cases, such a circuit should be added to the board externally (diode, choke coil and resistors as per instruction manual). It would be simpler to use an MX633 as a non-sound alternative to the MX630, equipped similarly as the MX645 (even suitable for gold caps).

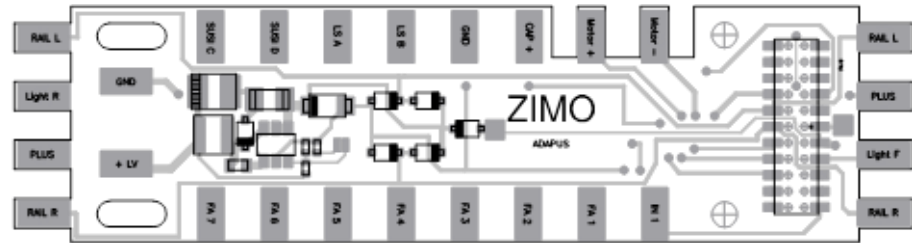

## 8 Predefined CV sets

The CV sets described below are available from software version 27.0, but **only in non-sound decoders**, like the MX620, MX621, MX630, MX631 and MX632. More CV sets will be added with future software versions.

There are no CV sets available for sound decoders; the corresponding tasks are part of the sound project CV list.

CV sets are lists of predefined CV settings that are embedded in the decoder software; when desired, one of these lists can be activated by a "pseudo-programming" of CV #8.

Decoders delivered as **"normal" decoders** don't have any of the existing lists activated; instead the CV's contain the "normal" default values as shown in the CV tables above. However, an existing CV set can be activated with the "CV #8" procedure (see below).

Decoders delivered as **"OEM" decoders**, i.e. decoders installed by a loco manufacturer, usually have a fitting CV set activated. If needed, the decoder can be set back to the "normal" (default) values with the "CV #8" procedure (see below).

### The existing CV sets that can be activated in non-sound decoders:

#### CV set, activate with CV #8 = 10

for **ROCO ICN** non-sound version with factory installed MX630P16. Deliveries began in August 2010.

CV #	2 = 4	Lowest speed step set for jerk free running of the ICN
	3 = 6	Acceleration
	4 = 2	Deceleration
	5 = 252	Top speed setting corresponds to default setting.
	6 = 85	Medium speed (speed curve)
	9 = 95	Motor regulation: High sample rate to prevent jerky behavior
	10 = 128	CV's #10, 113, 150 are set for full regulation up to top speed
	29 = 6	Analog operation activated, RailCom turned OFF
	56 = 33	PID-Control (BEMF) optimized for ICN
	105 = 161	ROCO ID code
	106 = 1	ROCO ID code
	113 = 255	CV's #10, 113, 150 are set for full regulation up to top speed
	122 = 31	Exponential braking (non-linear deceleration for smoother stops)
	144 = 128	Update lock to prevent accidental disruptions
	146 = 30	Gear back-lash compensation at direction change (ensures smooth starts)
	150 = 255	CV's #10, 113, 150 are set for full regulation up to top speed

#### CV set, activate with CV #8 = 11

created for **HAG** locomotives with MX631D decoder, as of June 2010.

CV #	3 = 3	Acceleration
	4 = 2	Deceleration
	9 = 88	Motor regulation: High sample rate and long sample time
	13 = 1	FO1 is turned ON in analog mode
	56 = 61	Low integral value in PID regulation (BEMF)
	58 = 170	Reduced motor regulation
	112 = 36	Motor control frequency set to 40 kHz
	124 = 128	SUSI deactivated; both connections are used as logic-level function outputs
	152 = 64	FA3, FA4 used for directions bit, for the control of ESU wiper reversing switch

#### CV set, activate with CV #8 = 12

created for **Hobby-Trade**, Decoder MX631D, as of October 2010.

CV #	3 = 15	Acceleration
	4 = 8	Deceleration
	6 = 120	Medium speed (Speed curve adjustment)
	35 = 12	Function assignment
	35 = 48	Function assignment
	124 = 2	Acceleration and deceleration momentum to be reduced to ¼ of CV #3 and 4.
	127 = 2	Directional taillights
	128 = 1	Directional taillights
	129 = 170	Direction dependence for other equipment
	130 = 36	Direction dependence for other equipment
	155 = 4	Half speed (low gear) with F4
	156 = 4	Momentum deactivation with F4

#### CV set, activate with CV #8 = 13

created for **Hobby-Trade**, Decoder MX631C ("Märklin" style or ESU design), as of October 2010.

CV #	3 = 10	Acceleration
	4 = 7	Deceleration
	35 = 0	No action with function key F1
	36 = 0	No action with function key F2
	37 = 0	No action with function key F3
	61 = 97	Standard function mapping replaced by the one without left-shift.
	124 = 4	Acceleration and deceleration momentum to be reduced to ¼ of CV #3 and 4.
	155 = 4	Half speed (low gear) with F4
	156 = 4	Momentum deactivation with F4

More CV sets were defined during 2011 to 2013 and added to the software of all non-sound decoders: Activate a CV set with **CV #8 = ...**

- = **14, 15, 16** for Roco articles 801088000, 801088001, 801088002 (Delivered WITHOUT RailCom)
- = **17, 18, 19, 22...28** for various Roco articles (Delivered WITH RailCom)
- = **29, 30, 31, 32, 33** for Fleischmann articles
- = **39** for Lemke ETA176/ESA176, **40** for KISS Silberlinge gauge 1

The CV sets for Roco vehicles differ from each other mainly in the areas of "Function Mapping "and lighting effects, other CVs are uniformly set as follows:

CV #	2 = 4	Start voltage
	3 = 6	Acceleration
	4 = 2	Deceleration
	5 = 252	Maximum speed
	6 = 85	Medium speed
	9 = 95	Motor regulation – EMF sampling time, rate; adaptation to motor type
	10 = 128	Regulation-Cutoff – intern. speed step (to 252), where CV #113 applies; med. speed here
	56 = 33	Motor regulation – PID-value; adaption to motor type
	105 = 161	free user data
	112 = 64	ZIMO configuration bits; the so called "Marklin brake" is activated here.
	113 = 255	Regulation-Cutoff – maximum regulation is set here at speed step in CV #10 (center)
	122 = 31	Exponential brake curve; soft slow-down in the lowest speed range
	144 = 128	Software update is locked; CV-programming is unlocked
	146 = 30	Gear backlash eliminated; adaptation to gearbox used
	150 = 255	Full motor regulation even at top speed

**The “CV #8” – procedure for handling these CV sets:**

Normally, the CV #8 contains the manufacturer identification number, which is “145” in ZIMO’s case. That value cannot be changed and is the reason why this CV can also be used for pseudo programming (pseudo because the entered value is not really saved) to execute various actions.

CV #8 is about a decoder’s HARD RESET (which is standardized for all decoders) as well as the programming of CV sets (only for ZIMO decoders).

**CV #8 = xx** (xx = Number of the desired CV set); a HARD RESET will be performed, where all CV’s part of a CV set are set back to the “CV set default” values, and the remaining CV’s to the default values of the decoder (according to the CV table in this instruction manual).

**CV #8 = 8** (this is the NMRA standard reset); all CV’s are restored to the values of the previous hard reset, i.e. the same CV set is reused as with the previous “CV #8 = xx” command; the remaining CV’s once again restore to the decoder’s default values.

This is also the correct HARD RESET for OEM cases, where a ZIMO decoder was installed by the loco manufacturer and the correct CV set was activated at that time.

Sound decoders are set back to the CV values as defined in the sound project. The above described CV sets are NOT valid for sound decoders.

CV #8 = 8 is therefore the “normal” HARD RESET if one wants to return to the starting point because programming errors have been made, for example.

**CV # 8 = 0** (this CV #8 procedure is NOT standardized and exists only in ZIMO decoders); all CV’s are reset to the default values as listed in the operating manual, regardless of any previously active CV sets or sound projects.

Individual CV’s can of course be programmed differently at any time, even after a CV set or a hard reset has been activated.

**Converting binary to decimal**

If, according to the CV table, a CV calls for setting individual bits (which is the case with CV #29, 112 and 124, for example) proceed as follows:

Each bit is assigned with a specific value:

Bit 0 = 1

Bit 1 = 2

Bit 2 = 4

Bit 3 = 8

Bit 4 = 16

Bit 5 = 32

Bit 6 = 64

Bit 7 = 128

The decimal values of all bits of the respective CV that are supposed to be set (Shown in the CV table as “Bit. = 1”) are added up. All other bits (“Bit...= 0”) are ignored. Note that bits are numbered from right to left.

Example:

Bit 0, 2, 4 and 5 are supposed to be set (Bit...=1); but not Bit 1, 3, 6 and 7 (Bit...=0).

This results in a bit-set of 00110101 and a decimal value of:

Bit 7	Bit 6	Bit 5	Bit 4	Bit 3	Bit 2	Bit 1	Bit 0
-------	-------	-------	-------	-------	-------	-------	-------

0	0	1	1	0	1	0	1
---	---	---	---	---	---	---	---

0 + 0 + 32 + 16 + 0 + 4 + 0 + 1 = 53 (decimal value)

The calculation in reverse:

A trial and error method is used to determine individual bits from a decimal figure: start with the largest value. If a number is larger or equal to 128 then Bit 7 = 1. If the remaining number is larger or equal to 64 then Bit 6 = 1 and so on.

Example: The decimal figure of 53 is neither larger or equal to 128, nor larger/equal to 64 but is larger than 32. Therefore Bit 7 = 0, Bit 6 = 0 but Bit 5 = 1; the rest of 21 (53 - 32 = 21) is larger than 16 (Bit 4 = 1), the remaining 5 (21 - 16 = 5) is not larger than 8 but is larger than 4 (Bit 3 = 0, Bit 2 = 1), and finally 1 (5 - 4 = 1) is not larger/equal to 2 but is equal to 1 (Bit 1 = 0, Bit 0 = 1).

## 9 ZIMO decoders and competitor systems

All Zimo decoders comply with NMRA standards and recommended practices and can be used on layouts with other brands of NMRA compliant systems.

What most systems of other manufacturers have in common, in contrast to ZIMO systems, is that track power is not stabilized or only partly stabilized and often relatively weak (both in regards to voltage and amperage). This can lead to uneven speeds and/or limited top speed because Zimo decoders are of course programmed by default to operate on stabilized and regulated track power from a Zimo command station of up to 24V.

It is recommended in such cases to:

- change **CV #57** (reference voltage) from "0" (automatic regulation based on given track voltage) to a fixed voltage. For example: "140" for a DCC system with a typical track voltage of 16 - 18V. In this case 14V will be used as reference, which leaves a certain safety margin during voltage drops. This does not apply to MX62 decoders, where a fixed value is always used.

### ZIMO decoder with Lenz "DIGITAL plus" from software version 2.0

This system uses 28 speed steps beginning with version 2.0 and 128 steps with version 3.0 and up. It also programs in direct mode according to NMRA DCC standards and is therefore fully compatible with Zimo decoders.

All Zimo decoders are set to 28 speed steps by default. Make sure the system is also set to 28 steps for the decoder address in question. Incompatibility will be the result if the speed steps between decoder and system do not agree with each other; which is most often noticed by non-working headlights. It would only make sense to switch the system from 14 steps to 28 or 128 speed steps, since setting the decoder back to 14 steps would result in an unnecessary poor drivability.

All configuration variables are accessible; see the cab manual in question for programming procedures. The address is located in the registry's position #1.

The configuration variables #49 to #54 will have no effect, since the signal controlled speed influence is only supported by Zimo systems.

### ZIMO decoder with ROCO Lokmaus-2

Although the Lokmaus-2 allows CV programming, its display is limited to two digits only and therefore limits the number of CV's and their values to 99.

Zimo decoders offer a special pseudo-programming feature with CV #7 (that normally stores the software version number) to allow unrestricted programming. It is called pseudo-programming because the permanently stored value in CV #7 cannot be overwritten but rather holds a temporary value that allows the Lokmouse2 to be used for expanded programming capabilities (see CV table); the engine must not be running during the programming procedure!

Example:

To enter a value of 160 (which is not possible with a Lokmouse-2 because value is >99) to CV #5 (max. speed) proceed as follows:

First program CV #7 to 1, followed immediately by setting CV #5 to 60. No power interruptions between those steps are allowed. Explanation: The value 1 in CV #7 actually 01 (tens digit=0 and ones digit=1) causes the decoder to add 100 to the CV **value** that will be entered in the next programming step. Therefore, a value of 60 entered to CV #5 with the Lokmouse2 is stored as 160!

Example:

To program CV #122 (exponential deceleration), for example, with a value of 25 do the following:

Again, go to CV #7 and enter a value of 10, then go to CV #22 and enter a value of 25.

Explanation: CV #7 = 10. The 1 in the tens digit causes the decoder to add 100 to the CV **address** in the following programming step. As a result, CV #122 will be programmed instead of CV #22!

### ZIMO decoder with DIGITRAX Chief

No problems expected with this system!

The Digitrax system usually operates at 28 or 128 speed steps. If for some reason the headlights don't work, confirm that indeed the system and the decoder are set to the same number of speed steps and if necessary, change the speed steps at your cab to 28 or 128 steps.

### Special procedures for DCC systems with limited CV range:

**Configuration variables #266 to #500** are used for the selection and allocation of sound samples as well as other settings. Programming CV's in this range is no problem for high-level systems (such as the current ZIMO DCC systems) both in "service mode" or "operations mode".

There are however many DCC systems in use (some still in production) that can only access CV's up to #255 or even worse to #127 or CV #99.

For such applications, ZIMO decoders offer an alternative way of reaching higher CV's via lower numbers. This is done with an initial "Pseudo-Programming" of

**CV #7 = 110 or = 120 or = 130**

which increases the CV numbers about to be accessed by 100 or 200. For example:

If programming CV #266 = 45 is not possible, programming CV #7 = 110 followed by CV #166 = 45 executes the desired programming of CV #266 = 45

or

if neither CV #266 = 45 nor CV #166 = 45 is possible, programming CV #7 = 120 followed by CV #66 = 45 also leads to the result of CV #266 = 45.

The initial CV #7 - "Pseudo-Programming" state - remains active for further programming (which means CV #267 is entered as #167, CV #300 as #200 and so on) until the decoder is powered down. ATTENTION: After re-booting the system, the "Pseudo-Programming" is lost, that is programming CV #166 is indeed accessing CV #166 again. See below to prevent this!

The "Pseudo-Programming" can also be stopped without power interruption with

**CV #7 = 0**

which means that the programming reverts back to the original CV #166.

Using as an initial "Pseudo-Programming"

**CV #7 = 210 or 220**

achieves the same results as above but remains active even after the system is powered down. This state can only be cancelled with

**CV #7 = 0,**

which is important to remember in order to program lower CV's again.

## Operating with Märklin MOTOROLA Systems

Using the MOTOROLA mode of a ZIMO decoder makes only sense if the system used is not capable of operating in the DCC format. DCC is substantially more powerful and should be the preferred protocol.

MOTOROLA (MM): 14 speed steps, 80 addresses, 4 functions compares to 126 speed steps, 10239 addresses and 28 functions with DCC.

The MOTOROLA format is recognized automatically by the decoder.

Addressing and CV programming is possible with the current **Mobile Station** as well as the **Märklin 6021 command station**. The procedure in the first case is automated and easy to do (see operating manual of the Mobile Station); with older systems however it is very tedious (because this system doesn't provide much help):

*Instruction for CV programming with the old Märklin 6021 central unit:*

*Start the programming mode by:*

1. selecting the address of the engine to be programmed
2. press the "STOP" key at the central unit and wait a few seconds
3. Crank the speed regulator past the left stop and hold (direction switch)
4. press the "START" key
5. release the speed regulator

*The front headlight of the engine should now be flashing once per second indicating that the decoder is in the programming mode.*

*You can now choose between two programming modes:*

1. *Short mode: programming is limited to CV's 1 – 79 and a value range from 0 – 79*
2. *Long mode: the values to be used in each case are split and transmitted in two steps (CV 1-799, value range 0-255)*

*The short mode is always active after entering the programming mode.*

*To change to the long mode write 80 to CV #80 (enter address 80 and change direction twice to change to the long mode).*

### ➤ **Short mode:**

*Enter the CV to be programmed in the central unit as an address and briefly operate the direction switch.*

*The headlight now quickly flashes twice.*

*Now enter the desired value for the selected CV and again operate the direction switch briefly (enter 80 for a value of 0).*

*The headlight flashes once indicating that you can program the next CV or end the programming by turning the track power off.*

### ➤ **Long mode:**

*Remember to set address 80 for a value of 0!*

*Enter the hundreds and tens digit in the central unit of the CV you want to program. For example: for CV 123 enter 12 and operate the direction switch.*

*The headlight now quickly flashes twice.*

*Now enter the ones digit of the same CV (for example: for CV 123 enter 03) and operate the direction switch again.*

*The headlight briefly flashes 3 times.*

*Enter the hundreds and tens digit in the central unit for the value you want to program and operate the direction switch.*

*The headlight briefly flashes 4 times.*

*Now enter the ones digit of the value and operate the direction switch again.*

*Again, the headlight flashes once indicating that you can program the next CV or end the programming by turning track power off.*

## 10 DC and AC Analog Operation

ZIMO decoders switch automatically to analog when DC voltage is present and CV #29 is set accordingly (Bit 2 = 1, which is the default setting).

Operation is possible with various power packs:

- "normal" DC throttles, with poor or no ripple control
- smooth power from a power supply unit
- PWM throttles such as the Roco analog mouse.

The following CV adjustments are possible for analog operation:

- ⇒ CV #14, Bit 7 = 0: Analog operation without motor regulation  
Bit 7 = 1: Analog operation with motor regulation (is of particular value with sound; for example: that the chuff frequency fits the wheel movements)
- ⇒ CV #14, Bit 6 = 0: Analog operation with momentum as per CV #3 and 4.  
Bit 6 = 1: Analog operation without momentum.
- ⇒ CV #13, CV #14: Select function outputs that should be ON in analog mode.

SUGGESTION: With extensive analog operation it is recommended to use the **update lock**

**CV #144, Bit 7, for example: CV #144 = 128,**  
to avoid interference and poor performance!

**ATTENTION:** Decoders of the **MX621 family** (miniature decoder) and **MX640** (older sound decoders) **do not** have the dielectric strength to cope with the surge pulses (>30V) required for direction change, as is used in the classic AC operation!

## 11 CV – Summary List

This list summarizes all CV's in numerical order, with very short descriptions (as a reminder). **Detailed information** can be found in the **preceding chapters** ("Configure", "ZIMO Sound").  
 The "red" column: Denotes the chapter the CV's belong to.

Chapter	CV	Denomination	Range	Default	Description
3.4	#1	Short address	1 – 127	3	The "short" (1-byte) loco address.
3.6	#2	Start voltage	1 - 255	1	Internal speed step applied as <b>lowest</b> external speed
3.7	#3	Acceleration rate	0 - 255	(2)	Multiplied by 0.9 equals' acceleration time.
3.7	#4	Deceleration rate	0 - 255	(1)	Multiplied by 0.9 equals' deceleration time.
3.6	#5	Top speed	0 - 255	1 (=255)	Internal speed step for <b>highest</b> external speed step.
3.6	#6	Medium speed	0 - 255	1 (=1/3 of #5)	Internal speed step for <b>medium</b> external speed step
3.3	#7	SW-Version Number	Read only	-	Current firmware version number. For subversion see CV #65.
3.3	#8	Manufacturer ID, Reset &Set	Read only	145 (=ZIMO)	Given by the NMRA. CV #8=8: Hard Reset.
3.6	#9	Motor control frequency	1 - 255	55	Tens digit for sampling rate, ones digit for sampling time.
3.6	#10	Compensation	0 - 252	0	Internal speed step for reduced intensity per CV #113.
-	#11	-----			
-	#12	-----			
3.5	#13	Analog functions F1...F8	0 - 255	0	Select analog functions F1 (Bit 0), F2 (Bit 1)...
3.5	#14	Analog functions F0, F9...	0 - 255	0	Select analog functions F0 forw (Bit 0), rev (Bit 1)...
-	#15	-----			
-	#16	-----			
3.4	#17, 18	Extended Address	128 -10239	0	The "long" (2-byte) addresses. Active only if Bit 5 in CV #29 is set to 1.
3.4	#19	Consist address	0 – 127	0	Consist address for 2 or more engines, valid if >0
3.4	#21	Consist function F1 - F8	0 - 255	0	Consist functions F1 (Bit 0), F2 (Bit 1)...
3.4	#22	Consist function F0	0 - 191	0	Select consist functions F0 forw (Bit 0), rev (Bit 1)...
3.7	#23	Acceleration variation	0 - 255	0	Temporary adaptation of CV #3 (Acceleration).
3.7	#24	Deceleration variation	0 - 255	0	Temporary adaptation of CV #4 (Deceleration).

Chapter	CV	Denomination	Range	Default	Description
-	#25	-----			
-	#26	-----			
3.10	#27	Asymmetrical stops (ABC)	0, 1, 2, 3	0	Bit 0 = 1: Stops if voltage in right rail, Bit 1 = 1: left rail
3.2	#28	RailCom Configuration	0 - 3	3	Bit 0 = 1: RailCom (Broadcast), Bit 1 = 1: RailCom Data
3.2	#29	Basic settings	0 - 63	14 = 0000 1110 Bit 3 = 1 ("RailCom" is switched on)	Bit 0 - Train direction: <u>0</u> = normal, 1 = reversed Bit 1 - Speed steps: 0 = 14, <u>1</u> = 28 Bit 2 - DC (analog): 0 = disabled, <u>1</u> = enabled Bit 3 – RailCom: 0 = deactivated, <u>1</u> = <b>activated</b> Bit 4 - Speed table: <u>0</u> = 3-point, 1 = 28-point Bit 5 - Decoder address: <u>0</u> = CV #1, 1 = CV #17+18
3.14	#33	NMRA Function map F0	0 - 255	1	Function mapping for F0 forward
3.14	#34	NMRA Function map F0	0 - 255	2	Function mapping for F0 reverse
3.14	#35-46	Function mapp. F1 - F12	0 - 255	4,8,2,4,8...	Function mapping for F1 ... F12
-	#47	-----			
-	#48	-----			
3.9	#49	HLU acceleration	0 - 255	0	Multiplied by .4 equals acceleration time in seconds
3.9	#50	HLU deceleration	0 - 255	0	Multiplied by .4 equals deceleration time in seconds
3.9	#51 - 55	HLU speed limits	0 - 255	20, 40...	Speed steps for each of the 5 HLU speed limits
3.6	#56	Motor regulation	0 - 255	55	PID regulation: P-value (tens), I value (ones digit)
3.6	#57	Voltage reference	0 - 255	0	Absolute voltage in tenth of a volt: max motor speed, = <u>0</u> : relative to track voltage.
3.6	#58	BEMF intensity	0 - 255	255	Intensity of back-EMF control at the lowest speed step.
3.9	#59	HLU delay	0 - 255	5	Tenth of a second delay after receiving new HLU limit
3.18	#60	Dimming	0 - 255	0	Reduction of function output voltage with PWM
3.14	#61	ZIMO ext. mapping	1,2...97,98	0	Configurations not covered by NMRA mapping
3.21	#62	Effects modifications	0 - 9	0	Change of minimum dimming value
3.21	#63	Effects modifications	0 - 99	51	Tens digit: cycle time, Ones digit: extends OFF time
3.21	#64	Effects modifications	0 - 9	5	Ditch light off-time modification
3.3	#65	Sub-Vers Number	Read only	-	Supplement to main version noted in CV #7.

Chapter	CV	Denomination	Range	Default	Description
3.6	#66	Forward trimming	0 - 255	0	Multiplication of the speed step by "n/128"
3.6	#67-94	Free speed table	0 - 255	0	Internal speed step for each of the 28 external steps
3.6	#95	Reverse trimming	0 - 255	0	Multiplication of the speed step by "n/128"
-	#96..	-----			
-	105, 106	User data	0 - 255	0	Free memory space for user data
3.16	#107	Light suppression	0 - 255	0	Light suppression on cab side 1 (front side)
3.16	#108	Light suppression	0 - 255	0	Light suppression on cab side 2 (rear)
-	#109	Extension of CV 107	1 - 6	0	3. Suppressed output (1 - 6 for FO1 - FO6)
-	#110	Extension of CV 108	1 - 6	0	3. Suppressed output (1 - 6 for FO1 - FO6)
3.1 3.6 3.20	#112	Special ZIMO configuration bits	0 - 255	4 = 00000100 with Bit 5 = 0 (20 kHz)	Bit 1 = 1: High frequency acknowledgement Bit 2 = 0/1: ZIMO loco number recognition OFF/ON Bit 3 = 1: 8-Function Mode (for old ZIMO systems) Bit 4 = 1: Pulse chain recognition (for old LGB) Bit 5 = 0/1: motor control frequency in 20/ 40 kHz Bit 6 = 1: "Märklin" brake (+ CV #29 Bit 2, #124, Bit 5) Bit 7 = 1: Pulse chain commands
3.6	#113	Compensation	0 - 255	0	Reduced BEMF intensity at speed step in CV #10.
3.19	#114	Dim Mask 1	Bits 0 - 7	0	Exclusion of individ. outputs from dimming per CV #60.
3.24	#115	Uncoupler control	0 - 99	0	With effect 48: Pull-in time (tens), hold volt (ones digit)
3.24	#116	Automatic uncouple	0 - 199	0	Unload (hundredths), drive time (tens), speed (ones)
3.20	#117	Flasher functions	0 - 99	0	Tens digit = ON time / Ones digit = OFF time
3.20	#118	Flashing mask	Bits 0 - 7	0	Selected function outputs will flash as per CV #117
3.19	#119	F6 low beam mask.	Bits 0 - 7	0	Selected outputs will dim with F6 according to CV #60.
3.19	#120	F7 low beam mask	Bits 0 - 7	0	Selected outputs will dim with F7 according to CV #60.
3.7	#121	Expon. acceleration	0 - 99	0	Tens digit: speed range, Ones digit: curve (0 to 9).
3.7	#122	Expon. deceleration	0 - 99	0	Tens digit: speed range, Ones digit: curve (0 to 9).
3.7	#123	Adaptive accel/decel	0 - 99	0	Tens digit: acceleration, Ones digit: deceleration
3.13	#124	Shunting keys, Outputs instead of SUSI	Bits 0 - 4, 6, 7	0	Shunting key (half speed, no momentum), switch SUSI to function outputs, DC braking.
3.22	#125 #126 #127 #128 #129 #130	Effects F0 front F0 rear F1 F2 F3 F4	0 - 255	0	Bits 1, 0 = 00: directional (active in both directions) = 01: only forward = 10: only reverse Bits 7, 6, 5, 4, 3, 2 = Effect-Code, i.e.: Uncoupler - 00110000 = "48"

Chapter	CV	Denomination	Range	Default	Description
	#131 #132	F5 F6			Soft-Start for function output - 00110100 = "52" Autom. Brake light and so on. - 00111000 = „56"
3.23	#133	FO4 for exhaust fan	0, 1	0	= 0 : FO4 as normal output = 1: for an exhaust fan.
3.10	#134	Asym. stopping (ABC)	1 - 14,101..	106	Hundreds: Sensitivity, Tens and Ones digit: Threshold
3.8	#135	Km/h - Speed	2 - 20	0	= 1 → Initiates a calibration run; 5, 10, 20: km/h step.
3.8	#136	Km/h - Speed	or	RailCom	Control value after calibration; or RailCom correction
3.23	#137 #138 #139	Smoke generator characteristic	0 - 255 0 - 255 0 - 255	0 0 0	Effect 72 / 80: CV #137: PWM of FOx at standstill CV #138: PWM of FOx at cruising speed CV #139: PWM of FOx at acceleration
3.12	#140	Distance controlled stopping	0-3, 11-13	0	= 1: HLU or ABC, = 2: manual, = 3: man. & auto stops.
3.12	#141	Distance controlled stopping	0 - 255	0	"Constant distance", Stop point: 255 = 500 yards
3.12	#142	Distance controlled stopping	0 - 255	12	High speed correction with ABC
3.12	#143	Distance controlled stopping	0 - 255	0	High speed correction with HLU
3.1	#144	Programing/Update Lock	Bits 6, 7	0	Bit 6 = 1: "Service Mode" lock, Bit 7 = 1: update lock.
3.6	#145	Alternative motor control	-	0	= 1: Special setting for Fleischmann round motor = 2:. = 10: "normal" C-Sinus and Softdrive-Sinus = 11: alternative C-Sinus / Softdrive Sinus = 12: special C-Sinus and Softdrive-Sinus = 13: special C- / Softdrive-Sinus control mode for the Märklin "Gottardo" engine
3.7	#146	Gear backlash	0 - 255	0	Hundredths of a second the motor spins at minimum rpm after direction change
3.6	147..	Experimental CV's	0 - 255	0	Special settings for motor control
3.6	#151	Motor brake	0 - 9	0	= 1 ... 9: Strength and reaction of the motor brake
3.19	#152	Dim Mask 2	Bits 0 - 7	0	Exclusion of individ. outputs from dimming per CV #60
-	#153	Continue w/o signal	0 - 255	0	Stops in tenths of seconds after the last DCC signal.
-	#154	Special OEM-Bits.			For certain sound projects only
3.13	#155	Half-speed key	0 - 19	0	Key for half-speed activation (instead of CV #124)
3.13	#156	Momentum deact.	0 - 19	0	Momentum deactivation key (instead of CV #124)
3.13	#157	MAN key.	0 - 19	0	Selecting a key for the MAN functions



Chapter	CV	Denomination	Range	Default	Description		
4.0 5.5 5.7	#158	Several sound bits + RailCom variants	0 - 127	4	Bit 0 = 1: SPECIAL MX648: Turns off external charging with FO1. Bit 1 = 1: DIESEL-MECHANICAL: No RPM increase when braking (see CV #364). Bit 2 = 0: old RailCom format with ID 4. = 1: current RailCom (kph) feedback with ID 7. Bit 3 = 1: "Looped" driving sounds will be faded out when switching to a different sound. Bit 4 = 1: Slows steam chuff frequency at high speed Bit 5 = 1: Braking (even by one speed step) causes the motor and turbo sounds to decrease by on sound step. Bit 6 = 1: Thyristor volume increases when braking Bit 7 = 1: SPECIAL MX645: ELECTRIC: Flashes of light (approx. 0.1 sec) on FO7 when switch gear sound is played.		
3.22	#159 #160	Effects for F7/F8	0 - 255	0	Same as CV"s #125 - 132 but for F7 and F8		
3.26	#161	Servo Protocol	0 - 3	0	Bit 0 = 0: positive pulses, = 1: with negative pulses. Bit 1 = 0: only active during movement, = 1: always		
3.26	#162 #163 #164 #165	Servo 1 left stop Servo 1 right stop Servo 1 center stop Servo 1 speed	0 - 255	49 205 127 30	Defines left stop position Defines right stop position for 3-position control Time in tenth of seconds between left and right stop		
	#166 #167 #168 #169	Servo 2 left stop Servo 2 right stop Servo 2 center stop Servo 2 speed		49 205 127 30	Defines left stop position Defines right stop position for 3-position control Time in tenth of seconds between left and right stop		
	#170 #171 #172 #173	Servo 3 left stop Servo 3 right stop Servo 3 center stop Servo 3 speed		49 205 127 30	Defines left stop position Defines right stop position for 3-position control Time in tenth of seconds between left and right stop		
	#174 #175 #176 #177	Servo 4 left stop Servo 4 right stop Servo 4 center stop Servo 4 speed		49 205 127 30	Defines left stop position Defines right stop position for 3-position control Time in tenth of seconds between left and right stop		
3.26	#181 #182 #183 #184	Servo 1 Servo 2 Servo 3 Servo 4	0 - 114	0 0 0 0	Operating modes (Single key, dual keys...)		
	#185	Special live steam		1 - 3	0	Settings for live steam engine	
	--	#186 - 189		Special pantograph configurations	-	0	Pantograph settings for special projects
	3.22	#190 - 191		Dimming times with effect 88	0-255		Turn-ON/OFF times for effects 88, 89 and 90
3.3	#250	Decoder-ID	Read only	-	Serial number given during production		

Chapter	CV	Denomination	Range	Default	Description
3.3	251 252 253				
	#260 261 262 263	"Load code" for "coded" sound projects	-	-	The commercially available "load code" entitles the user to install and playback "coded" sound projects of a selected supplier.
	-	#264	-----		
	5.0 5.3	#265	Select from sound collection	1 - 32 101 - 132	1
5.3 - 5.7	#266	Total volume	0 - 255	65	!!: >65: Over modulated, may damage speaker
5.5	#267	Chuff sound frequency	0 - 255	70	Only if CV #268 = 0; "Virtual cam sensor"
5.5	#268	Switching to real cam sensor	0 - 255	0	Bit 0 = 0: "Virtual cam sensor" Bit 0 = 1: real cam sensor
5.5	#269	Accentuated lead-chuff	0 - 255	0	Increases volume of 1 chuff beat
5.5	#270	Longer chuff length at very low speeds	0 - 255	0	
5.5	#271	Overlapping effect at high speed	0 - 255	16	Overlapping chuff beats
5.5	#272	Blow-off duration	0 - 255	50	= 0: no blow-off sound, > 0: Time in tenth of a sec (Value 50 = 5 Seconds)
5.5	#273	Start-up delay during blow-off	0 - 255	0	= 0: No delayed start, > 0: Time in tenth of a sec (Value 50 = 5 Seconds)
5.5	#274	Blow-off schedule	0 - 255	30	The blow-off sound is suppressed if the engine wasn't standing still for the time defined here.
5.3, 5.6	#275	Chuff sound volume at low speed and no-load	0 - 255	60	Chuff volume at low speed and "basic load". Automatic load test is necessary (CV #302=75).
5.6	#276	Volume at high speed and no-load	0 - 255	80	Chuff volume at high speed (full throttle). Automatic load test is necessary (CV #302=75).
5.6	#277	Chuff volume changes according to load	0 - 255	0	When deviating from the basic load, the chuff beat volume should be increasing (on inclines) or decreasing on declines (even muted).
5.6	#278	Load change threshold	0 - 255	0	Sound should not change with small load changes (i.e. in curves)
5.6	#279	Reaction speed to load change	0 - 255	0	Delaying sound changes when load changes.
5.7	#280	Load influence on Diesel engines	0 - 255	0	= 0: No influence; = 255: largest influence; Automatic load test is necessary (CV #302=75).
5.6	#281	Acceleration threshold for	0 - 255	1	Acceleration sound (chuff beats) changes to full volume from the speed step defined here.

Chapter	CV	Denomination	Range	Default	Description
		full load sound			
5.6	#282	Duration of acceleration sound	0 – 255	30	Time in tenth of a second
5.6	#283	Chuff sound volume during full acceleration	0 – 255	255	The volume of steam chuffs at maximum acceleration.
5.6	#284	Threshold for deceleration sound	0 – 255	1	Steam chuffs are played back at less volume (or muted) signifying the reduced power requirement during deceleration.
5.6	#285	Duration of reduced volume during deceleration	0 – 255	30	After the speed has been reduced, the sound should remain quieter for a specified time
5.6	#286	Volume level during deceleration	0 – 255	20	Defines the chuff volume during deceleration (Default: 20 = pretty quiet but not muted).
5.4	#287	Brake squeal threshold	0 – 255	20	The brake squeal should start when the speed drops below the specified speed step.
5.4	#288	Minimum driving time w/o brake squeal	0 – 255	50	Minimum driving time before brake squeal is played back.
5.7	#289	Thyristor: Stepping effect	1 – 255	1	= 1: no stepping effect, continuous ascend > 1: ascending scale according to the corresponding speed step interval.
5.7	#290	Thyristor sound, pitch at medium speed	0 – 100	40	
5.7	#291	Thyristor sound, pitch at maximum speed	0 – 100	100	
5.7	#292	Thyristor: speed step for medium speed	0 – 255	100	
5.7	#293	Thyristor control, Volume at steady speed	0 – 255	100	
5.7	#294	Thyristor control, Volume during acceleration	0 – 255	50	
5.7	#295	Thyristor control, Volume during deceleration	0 – 255	100	
5.7	#296	Electric motor, maximum sound volume	0 – 255	100	
5.7	#297	Electric motor, lowest speed step	0 – 255	30	Internal speed step at which the motor sound becomes audible.

Chapter	CV	Denomination	Range	Default	Description
5.7	#298	Electric motor sound, volume dependent on speed	0 – 255	100	Volume increase dependent on speed.
5.7	#299	Electric motor sound, Sound pitch dependent on speed	0 - 100	100	Sound pitch increase dependent on speed.
	#300	Pseudo programming	0 – 255	0	For various sound sample mappings.
	#301	Pseudo programming	0 – 255	0	For "Incremental Programming" of sound CV's
5.3	#302	Load test	75 – 76	75	Automatic load test
3.7	#309	Brake key	0 – 29	0	Number defines a brake key (Brake curve is defined in CV #349)
5.4	#310	Sound ON/OFF key	0 – 255	8	Number defines a key for sound ON/OFF functions.
5.4	#311	Function sound ON/OFF key	0 – 29	0	Defines an ON/OFF key for sounds that play back with function keys. = 0: Function sound is always ON.
5.4	#312	Blow-off key	0 – 29	0	Defines a water blow-off key.
5.4	#313	Mute key	0 – 29, 101 – 129	0	Mutes all sounds
5.4	#314	Mute fade in/out time	0 – 255	0	= 0 (to 10): minimum time setting of 1 sec. = 11...255: longer "fade" times
5.1 5.8	#315	Random generator Z1 Minimum interval	0 – 255	1	Defines the shortest possible interval between two consecutive pulses.
5.8	#316	Random generator Z1 Maximum interval	0 – 255	60	Defines the maximum time interval between two consecutive pulses
5.8	#317	Random generator Z1 Playback length	0 – 255	5	Times the random sound is repeated. = 0: Sound is played back only once.
5.8	#318	Random generator Z2 Minimum interval			See Z1
5.8	#319	Random generator Z2 Maximum interval			See Z1
5.8	#320	Random generator Z2 Playback length			See Z1
5.8	321-338	Random generator Z3 – Z8			
5.7	#339	Raising-Key	0 – 29	0	Defines a key to raise the diesel sound

Chapter	CV	Denomination	Range	Default	Description
5.7	#340	Coasting-Step	0 – 255	0	Diesel step the sound should be raised to and possible more "raising" keys.
5.1 5.8	#341	Switch input 1 Playback duration	0 – 255	0	The sound sample allocated to switch input 1 is played back for the duration defined with this CV.
5.8	#342	Switch input 2 Playback duration	0 – 255	0	The sound sample allocated to switch input 2 is played back for the duration defined with this CV.
5.8	#343	Switch input 3 Playback duration	0 – 255	0	The sound sample allocated to switch input 3 is played back for the duration defined with this CV.
5.7	#344	Run time of cooling fan after stop	0 - 255	0	Cooling fan (or other equipment) keeps running for 0-25.5 Seconds after coming to a stop
5.7	#345	Sound switch key	0 - 29	0	Switches between sound sets of multi-system locomotives.
5.7	#346	Switch conditions	0 – 2	0	= 0 -> Switches only when sound is OFF = 1 -> Switches also when stopped with sound ON = 2 -> Switches w. stopped or running with sound ON
5.7	#347	Solo driving	0 – 29	0	Defines a key for solo driving (engine only).
5.7	#348	Switch-over parameters for driving solo	0 - 4	0	=0 -> no function. =1 -> Diesel sound revs up unhindered to maximum rpm (as if CV #389=255) =2 -> reduced CV #3, CV #4 as per CV #390 =4 -> moves diesel sound thresholds up as in CV #391 if Bit2=0, CV #391 is always active.
3.7	#349	Brake time	0 – 255	0	As in CV 4. Brake key is defined with CV #309.
5.7	#350	Switchgear lock-out	0 – 255	0	Delay of switchgear sound at start-up.
3.23	#351	Exhaust fan speed when cruising	0 – 255	0	PWM settings of fan at cruising speed.
3.23	#352	Exhaust fan speed at motor starts and during acceleration	0 – 255	0	PWM settings at start-up and acceleration.
3.22, 3.23	#353	Automatic smoke shut-down	0 – 255	0	Turns the heating element of the smoke generator OFF after the time defined here.
3.23, 5.5	#354	Steam chuff frequency at speed step 1	0 – 255	0	Correction value to CV #267
3.23	#355	Exhaust fan speed at stand-still	0 – 255		PWM setting of fan at stand-still.
	#356	-	-	-	-
5.5, 5.7	#357	Thyristor control, Volume decrease at higher speeds	0 - 255	0	Internal speed step at which the thyristor sound volume should be reduced.
5.7	#358	Thyristor control, Volume reduction	0 – 255	0	Defines a curve as to how the thyristor sound should be lowered at the speed step defined in CV #357.
5.7	#359	Switch gear playback time	0 – 255	0	Time in tenth of a second the switch gear should be heard during speed changes.

Chapter	CV	Denomination	Range	Default	Description
5.7	#360	Switch gear playback after stop	0 – 255	0	How long the switch gear should be played back after coming to a stop.
5.7	#361	Switch gear sound playback delay	0 – 255	20	Switch gear sound delay when accelerating.
5.7	#362	Switchover threshold for 2nd thyristor	0 – 255	0	Defines a speed step at which a second thyristor sound for higher speeds is played back.
5.7	#363	Switch gear sound Speed / shift steps	0 – 255	0	Number of shift steps to cover the whole speed range.
5.5 5.7	#364	Diesel-Mechanical: Upshift RPM	0 – 100	0	Defines the typical drop in speed when shifting up.
5.7	#365	Diesel-Mechanical: Max. RPM before upshift	0 – 100	0	Defines the highest rpm before shifting up.
5.7	#366	Maximum turbo sound volume	0 – 64	0	Turbo volume
5.7	#367	Turbo rpm dependency on speed	0 – 255	0	Turbo playback frequency depending on engine speed.
5.7	#368	Turbo rpm dependency on accel/decel.	0 – 255	0	Playback frequency depends on the difference of set speed to actual speed.
5.7	#369	Minimum load for turbo	0 – 255	0	Audibility threshold for turbochargers.
5.7	#370	Frequency increase of turbo	0 – 255	0	Speed of frequency-increase of the turbocharger.
5.7	#371	Frequency decrease of turbo	0 – 255	0	Speed of frequency-decrease of the turbocharger.
5.7	#372	Electric motor, Volume dependent on acceleration	0 - 255	0	Acceleration volume
5.7	#373	Electric motor, Volume dependent on braking	0 – 255	0	Deceleration volume
5.7	#374	Coasting-Key	0 – 29	0	Forces the sound to a specified speed step (CV # 374)
5.7	#375	Coasting Step	0 – 255	0	Speed step for coasting key.
5.4	#376	Driving sound volume	0 – 255	0	0 or 255 = Full volume
	#377	-----	-	-	-
5.7	#378	Acceleration switchgear sparks	0 – 255	0	Likelihood for sparks when accelerating (0=always, 1=very rarely, 255=almost always)
5.7	#379	Deceleration switchgear sparks	0 - 255	0	Likelihood for sparks when decelerating (0=always, 1=very rarely, 255=almost always)
5.7	#380	Electrical brake key	0 – 29	0	1 – 28 = F1 – F28; 29 = F0
5.7	#381	Electric brake - minimum speed	0 – 255	0	No electric brake sound below this speed.

Chapter	CV	Denomination	Range	Default	Description
5.7	#382	Electric brake - maximum speed	0 – 255	0	No electric brake sound above this speed.
5.7	#383	Electric brake - Pitch	0 – 255	0	0=Pitch independent of speed, 1-255=increases playback speed
5.7	#384	Electric brake – Deceleration threshold	0 – 255	0	The number of speed steps to be reduced during deceleration before the electric brake sound is played back.
5.7	#385	Electric brake – Downhill (neg. motor load)	0 - 255	0	= 0: no effect at “negative” load = 1 – 255: Sound triggered at “negative” load.
5.7	#386	Electric brake – Loop	0 - 15	0	Bit 3 = 0: Sound fades out at the sample end = 1: Sound ends without fading at end Bit 2...0: Increases playback time (0-7=0-7 seconds).
5.7	#387	Acceleration influence	0 – 255	0	Acceleration influence on diesel sound steps.
5.7	#388	Deceleration influence	0 – 255	0	Deceleration influence on diesel sound steps.
5.7	#389	Acceleration limit of diesel sound	0 – 255	0	Limits how far the sound step may deviate during acceleration from the actual speed.
5.7	#390	Momentum reduction - driving solo	0 – 255	0	Reducing CV #3, CV #4 when “Solo” driving key is engaged.
5.7	#391	Idle sound, when driving solo	0 – 255	0	Keep sound at idle up to this speed step when driving “solo”.
	#392	-	-	-	-
	#393	ZIMO-Config. 5	0 – 255	0	Bit 0 = 1: activate ditch light if bell is played Bit 1 = 1: activate ditch light if horn is played
3.25 5.5	#394	ZIMO-Config. 4	0 – 255	0	Various bit configurations.
5.4	#395	Maximum volume	0 – 255	0	Max. volume for key defined with CV# 396, /#397
5.4	#396	Volume decrease key	0 – 29	0	
5.4	#397	Volume increase key	0 – 29	0	
5.7	#398	Automated coasting	0 – 255	0	The number of speed steps the train’s speed has to be reduced within 0.5 seconds in order for the automatic coasting effect to set the motor sound to idle.
3.17	#399	“Rule 17”, Speed dependent headlights	0 – 255	0	Switches to high beam at speed defined here. SEE CV #430 - !
3.18	#400 - #428	Input-Mapping	0 – 255	0	Matching function key (External Function) to function outputs F0 - F28.

Chapter	CV	Denomination	Range	Default	Description
	#429	-----	-	-	-
3.17	#430 #436 #442 #448 #454 #460 #466 #472 #478 #484 #490 #496 #502	Function-Key From SW 32.0 “Swiss” light mapping!	0 – 157	0	Value range: 0,1-29 The key defined here switches the function outputs listed under A1 and A2 ON or OFF. 1 – 28 for function keys F1 – F28, F29 is for F0. From SW 35.0: F-Key value + 128 (Bit 7 set) = Function inverted
3.17	#431 #437 #443 #449 #455 #461 #467 #473 #479 #485 #491 #497 #503	Master light switch	0 – 255	0	0=nothing defined,1-28 for Key F1-F28, 29 for F0 If Bit 7 is set (Value +128): The F-Key outputs will only turn on when the M-Key is also on.  If Bit 6 is set (Value +64): The M-Key outputs will not be turned off when the F-key is on and driving in forward direction.  If Bit 5 is set (Value +32): The M-Key outputs will not be turned off when the F-key is on and driving in reverse direction.  255=High beam function for any F-key – ONLY when the output in ON and dimmed (via CV #60, CV #114 or CV #152!
3.17	#432 #438 #444 #450 #456 #462 #468 #474 #480 #486 #492 #498 #504	A1 Forward	0 - 255	0	Value range: 0, 1-13, 14-15 1. Output to be switched on in forward direction. 0=no output, 1-13=FO1-FO13, 14=FO0v, 15=FO0r. Bit 7-5: Refers to 5 PWM-Config-CVs(508-512). Configuration 6 (1100xxxx) Output is turned off. Config. 7 (1110xxxx) Output is turned on.
3.17	#433 #438 #445 #451 #457 #463	A2 Forward	0 – 255	0	Value range: 0, 1-13, 14-15 2. Output to be switched on in forward direction. 0=no output, 1-13=FO1-FO13, 14=FO0v, 15=FO0r. Bit 7-5: Refers to 5 PWM-Config-CVs(508-512).

Chapter	CV	Denomination	Range	Default	Description
	#469 #475 #481 #487 #493 #499 #505				Configuration 6 (1100xxxx) Output is turned off. Config. 7 (1110xxxx) Output is turned on.
3.17	#434 #440 #446 #452 #458 #464 #470 #476 #482 #488 #494 #500 #506	A1 Reverse	0 – 255	0	Value range: 0, 1-13, 14-15 1. Output to be switched on in reverse direction. 0=no output, 1-13=FO1-FO13, 14=FO0v, 15=FO0r. Bit 7-5: Refers to 5 PWM-Config-CVs(508-512). Configuration 6 (1100xxxx) Output is turned off. Config. 7 (1110xxxx) Output is turned on.
3.17	#435 #441 #447 #453 #459 #465 #471 #477 #483 #489 #495 #501 #507	A2 Reverse	0 – 255	0	Value range: 0, 1-13, 14-15 2. Output to be switched on in reverse direction. 0=no output, 1-13=FO1-FO13, 14=FO0v, 15=FO0r. Bit 7-5: Refers to 5 PWM-Config-CVs(508-512). Configuration 6 (1100xxxx) Output is turned off. Config. 7 (1110xxxx) Output is turned on.
3.17	#508	Swiss-Mapping PWM Value 1	0, 8 – 248	0	PWM-Value in Bit 7-3 - 0=Off, 248=100%
3.17	#509	Swiss-Mapping PWM Value 2	0, 8 – 248	0	PWM-Value in Bit 7-3 - 0=Off, 248=100%
3.17	#510	Swiss-Mapping PWM Value 3	0, 8 – 248	0	PWM-Value in Bit 7-3 - 0=Off, 248=100%
3.17	#511	Swiss-Mapping PWM Value 4	0, 8 – 248	0	PWM-Value in Bit 7-3 - 0=Off, 248=100%
3.17	#512	Swiss-Mapping PWM Value 5	0, 8 – 248	0	PWM-Value in Bit 7-3 - 0=Off, 248=100%

## 12 Service Notes

Even Zimo decoders can break down ... sometimes "for no reason", sometimes due to short circuits during installations, sometimes by a failed update ... These defective decoder can of course be sent to Zimo for repair or replacement. Whether this is covered by warranty or a payable service, the submitter should expect a decoder back that is not only functional, but is also configured similarly as the original (i.e. the same CV values and the same sound project). However, this is not possible if the decoder is damaged so badly that it cannot be read-out anymore.

**THEREFORE ...** is it **recommended** to READ OUT IMPORTANT DATA from the decoder before it is defective and to record this information along with the personal information on the repair form:

Address  
 Loaded SW version (CV #7, 65)  
 Possibly activated CV Set (activation code for CV #8, concerns non-sound decoder)  
 Decoder ID (CV #250 ... 253, if available)  
 Possibly load code (CV #260 ... 263, relates to sound decoder)  
 Loaded sound project.

It would also be **very useful** (but relatively complex) to read out the entire CV list and keep it in a safe place, so it can later be programmed to a repaired decoder (which sometimes requires a hard-reset) or a replacement. Reading out and reprogramming decoders is easy with the help of

the program "ADaPT" (from E.Sperrer, works with Zimo and some other DCC systems),  
 or ZSP (works with MX31ZL MXDECUP or, in the future, with MXULF or MX10)  
 or with ZSC (works with MXULF in the future or MX10).

NOTE: Future Zimo command stations will read decoder configurations automatically (in the background) and make it available when needed. But is at the time of this writing (May 2013) still future...

ADDITIONAL INFORMATION relating to submission of defective decoders:

- To avoid unnecessary repair shipments it should be verified beforehand whether a defect is in fact present. Many of the submitted decoders are only configured wrong and all that was needed was a "hard reset" (CV #8 = 8) to get the decoder CV's back to the default values or the default values of a sound project.
- WARNING: Sometimes defects are simulated when a loaded sound project or its integrated CV table expects a specific loco model (e.g., certain types of lighting equipment), but the equipment is missing or not wired appropriately. Typical cases: The light is no longer working with F0 (because the sound project has redirected the light to another function key), or the locomotive will "drive off unchecked" (because the sound project activated a servo with a corresponding uncoupling procedure).

Note: for each sound project in the Zimo sound database there is usually also a version available that contains only the sound, which does not require a specially prepared vehicle.

- If the problem is "only" very poor drivability, it would be of advantage to contact [service@zimo.at](mailto:service@zimo.at) before sending the decoder back. Often a simple remedy can be found without sending the decoder back.
- ZIMO can only accept decoders for repair, BUT NOT complete engines or engine parts with a decoder installed. There are of course exceptions in problematic cases that have to do with the interaction between the locomotive and decoder, but only after prior agreement.
- The defect (or reason for return) should be described with as much detail as possible in addition to the above mentioned information required.
- So called OEM decoder, such as have been installed by a loco manufacturer, should be taken care of by them. However, ZIMO will repair these as well when sent to the ZIMO service department. The warranty and repair conditions may of course differ from those of the vehicle manufacturer (whether this is "better" or "worse" is rather coincidence). Even in these cases: submit only the Zimo decoder, not complete engines!

If a decoder gets exchanged, the original OEM sound project can in most cases be used in the replacement decoder as well (if the necessary information has been submitted to us). This applies to vehicle manufacturers like Roco, Fleischmann, Wunder, Demko and many others, but it is also possible that ZIMO does not have the sound from manufacturers that provided the sound themselves.

- "Preloaded" sound projects (see Sound Database), however, are usually NOT available from Zimo, but only the author / company who usually provides the sound only as preloaded in a decoder. Such sound decoders are therefore better sent directly to the original supplier. Naturally if the problem is a pure hardware issue, such as a defective motor or function output, it can be dealt easily at ZIMO.

Please fill out and accompany a ZIMO repair form with your shipment. Such forms can be downloaded here:

[http://www.zimo.at/web2010/sales/Reparatur-Formular\\_en.pdf](http://www.zimo.at/web2010/sales/Reparatur-Formular_en.pdf)

**ZIMO REPAIR**  
 to insert for repair entries or taxes, even for warranty

ZIMO ELEKTRONIK GmbH  
 customer service  
 Schönbrunner Straße 188  
 A - 1120 Vienna

Assignment (to be completed by ZIMO)  
 Entrance: .....  
 Exit: .....

Date: .....

product: [input field]

IMPORTANT DATES for decoder

date of purchase (approximately)	distributor (if known)	decoder ID (CV # 250, ...)	loaded SW version (CV # 7, 65)
error description:	also: How it came to failure?	loaded sound project	load-code (CV # 260, ...)

continued second page     error description, see email from

Name and address  
(when sending multiple projects it is sufficient to specify the full address only once, otherwise only the name)

Phone: .....

**13 INDEX**

6 (F, N) pin connector.....	54	Deceleration trimming.....	19	Load Code.....	13	Shunting.....	23
6 or 8 pin NMRA interface.....	54	Decoder Type.....	4	LOCO Number ID.....	17	Shunting, Half-Speed Functions.....	23
ABC High-Speed Correction.....	21	Decoder-ID.....	13	Loco Type Selection with CV #265.....	39	Signal contr. speed influence" (HLU).....	20
Acceleration Trimming.....	19	Diesel & Electric Sound.....	49	Logic Level Outputs - Connection.....	55	Smoke Effect.....	See
Accentuated Lead Chuff.....	46	Diesel engine, load influence.....	49	Logic-Level Outputs.....	36	SOUND.....	38
ADAPTER boards.....	65	Diesel smoke effect.....	33	Low/high beam mask.....	32	Sound Collection.....	39
Adaptive.....	19	Diesel-mechanical.....	49	Märklin MOTOROLA.....	70	Sound Projects.....	39
Analog functions.....	15	DIETZ sound modules.....	55	Medium Speed Setting.....	15	Sound Selection.....	40
Analog Operation.....	70	Dimming.....	31	Momentum.....	18	Special Effects.....	33
Asymmetrical threshold.....	21	Directions dependent taillights.....	27	Motor Brake.....	18	Special ZIMO Configuration Bits.....	12
Background sounds.....	40	Distance controlled stopping.....	22	Motor Control Frequency.....	16	Speed Table.....	15
Background sounds - Volume.....	45	Electric brake.....	52	Mph – Speed Regulation.....	19	Start Voltage.....	15
Basic Settings.....	13	Electric coupler effect.....	33	MTC Interface.....	56	Steam and Diesel smoke programming.....	33
Basic settings independent of powertrain ..	44	Electric Coupler Installation.....	56	Mute.....	44	Steam engine - Basic sound settings.....	46
BEMF Motor Regulation.....	16	Electric motor sound.....	49	NMRA-DCC function mapping.....	24	Steam engine - Load & accel. dependency	47
BEMF Reference Voltage.....	16	Electric Uncouplers.....	35	Noise Suppression Components.....	54	SUSI-Interface.....	36
Bidirectional communication.....	37	Energiespeicher.....	62	ON/OFF key.....	44	Swiss Mapping.....	29
Blow-off sETTINGS.....	46	Experimental CV's.....	18	Operations Mode Programming.....	13	Switch input sounds.....	42
Brake squeal.....	44	Exponential Acceleration.....	19	Overlapping effect at high speed.....	46	Switch Input sounds.....	52
CAM SENSOR.....	59	Extended (long) Address.....	14	PluX Interface.....	57	Switch input sounds - Volume.....	45
Chuff sound frequency.....	46	External Energy Source.....	60	Programming Lock.....	12	Switchgear Sound.....	49
Chuff Sound Volume.....	47	First time sound decoder operation.....	39	Pseudo-Programming.....	13	Switching to real cam sensor.....	46
Coasting-Key.....	52	Flasher Effect.....	33	Pulse Chains.....	33	SW-Version Number.....	13
Coasting-Step.....	52	Flashing mask.....	33	RailCom.....	37	Synchronized steam or Diesel Smoke.....	35
Competitor Systems.....	69	Function key sounds.....	41	Random sounds.....	42	The extended ZIMO function mapping.....	24
Connecting servo.....	58	Function sounds - Volume.....	45	Random sounds - Volume adjustments ..	45	The test run.....	43
Consist address.....	14	Gear Backlash.....	19	ROCO Lokmaus.....	69	The vehicle address.....	13
Converting binary to decimal.....	68	Gearbox.....	18	Rule 17.....	29	Thyristor sound.....	49
Crawling chuffs.....	47	Half-Speed.....	23	Second dim value.....	32	Top Speed Setting.....	15
CV #300 procedures.....	40	HARD RESET.....	13	Select loco type.....	44	Total volume.....	44
CV #400 Pcedure (Input Mapping).....	31	High/Low beam.....	31	Selecting another chuff set.....	40	Turbocharger sound.....	49
CV sets.....	67	HLU High-Speed Correction.....	22	Service Mode Programming.....	12	Unilateral Light Suppression.....	28
DC Brake Sections, "Märklin mode".....	22	Incremental Programming.....	43	Servo Configuration.....	36	US and other lighting effects.....	33
Deceleration rate.....	19	Input Mapping.....	31	SHIFT key between two sounds.....	49		